



WI300

Digital Projector

Home Cinema Series

User Manual

Table of contents

Important safety instructions 3

Projector features..... 7

Shipping contents8

Projector exterior view.....9

Controls and functions 11

Positioning your projector 16

Choosing a location..... 16

Obtaining a preferred projected image size..... 17

How to determine the position of the projector for a given screen size..... 17

How to determine the recommended screen size for a given distance 17

Shifting the projection lens21

Connection 22

HDMI connection22

Component Video connection23

Video connection.....24

Computer/PC connection.....25

Connecting video source devices.....26

Playing sound through the projector27

Operation 28

Starting up the projector28

Adjusting the projected image29

Using the menus.....31

Securing the projector32

Utilizing the password function32

Switching input signal..... 35

Using the preset and user modes..... 36

Advanced picture quality controls..... 39

Adjusting the sound 42

Selecting the aspect ratio..... 43

Magnifying and searching for details... 45

Playing 3D function 45

Personalizing the projector menu display 45

Operating in a high altitude environment..... 46

Locking control keys..... 46

Hiding the image 47

Freezing the image..... 47

Shutting down the projector 47

Menu operation 48

Maintenance 58

Care of the projector 58

Lamp information 59

Troubleshooting..... 65

Specifications..... 66

Projector specifications..... 66

Dimensions 67

Timing chart..... 68

Warranty and Copyright information73

Important safety instructions

Your projector is designed and tested to meet the latest standards for safety of information technology equipment. However, to ensure safe use of this product, it is important that you follow the instructions mentioned in this manual and marked on the product.

Safety Instructions

1. **Please read this manual before you operate your projector.** Save it for future reference.

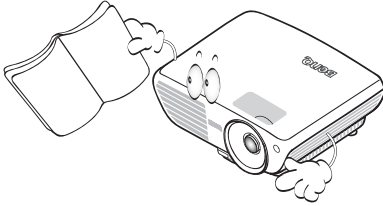

2. **Do not look straight at the projector lens during operation.** The intense light beam may damage your eyes.

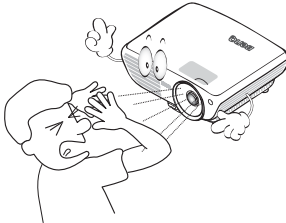

3. **Refer servicing to qualified service personnel.**

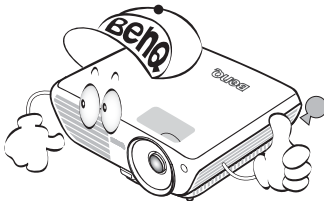

4. **Always open the lens shutter or remove the lens cap when the projector lamp is on.**

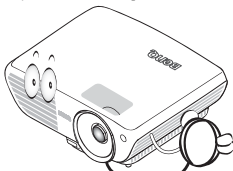

5. In some countries, the line voltage is NOT stable. This projector is designed to operate safely within a mains voltage between 100 to 240 volts AC, but could fail if power cuts or surges of ± 10 volts occur. **In areas where the mains voltage may fluctuate or cut out, it is recommended that you connect your projector through a power stabilizer, surge protector or uninterruptible power supply (UPS).**

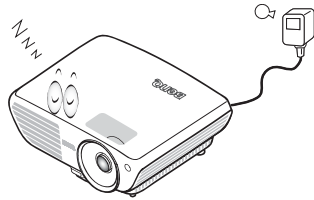

6. Do not block the projection lens with any objects when the projector is under operation as this could cause the objects to become heated and deformed or even cause a fire. To temporarily turn off the lamp, press **BLANK** on the projector or remote control.

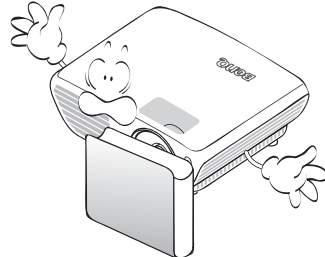

Safety Instructions (Continued)

7. The lamp becomes extremely hot during operation. Allow the projector to cool for approximately 45 minutes prior to removing the lamp assembly for replacement.

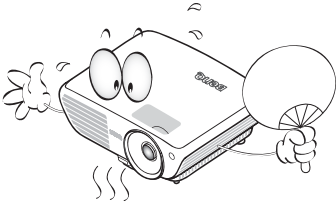

8. Do not operate lamps beyond the rated lamp life. Excessive operation of lamps beyond the rated life could cause them to break on rare occasions.

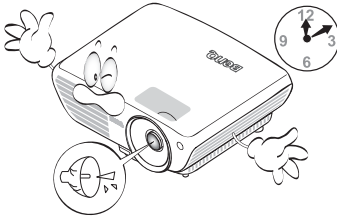

9. Never replace the lamp assembly or any electronic components unless the projector is unplugged.

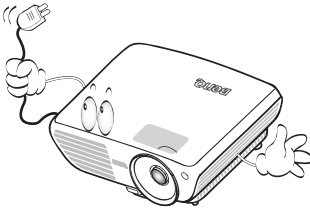

10. Do not place this product on an unstable cart, stand, or table. The product may fall, sustaining serious damage.

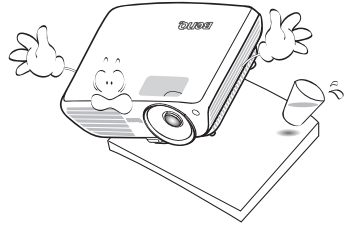

11. Do not attempt to disassemble this projector. There are dangerous high voltages inside which may cause death if you should come into contact with live parts. The only user serviceable part is the lamp which has its own removable cover. Under no circumstances should you ever undo or remove any other covers. Refer servicing only to suitably qualified professional service personnel.

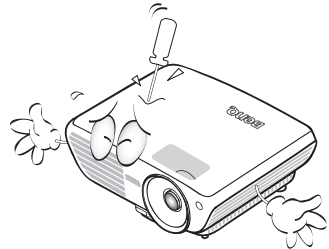

12. When the projector is under operation, you may sense some heated air and odor from its ventilation grill. It is a normal phenomenon and not a product defect.

Safety Instructions (Continued)

13. Do not place this projector in any of the following environments.
- Space that is poorly ventilated or confined. Allow at least 50 cm clearance from walls and free flow of air around the projector.
 - Locations where temperatures may become excessively high, such as the inside of a car with all windows rolled up.
 - Locations where excessive humidity, dust, or cigarette smoke may contaminate optical components, shortening the projector's life span and darkening the image.

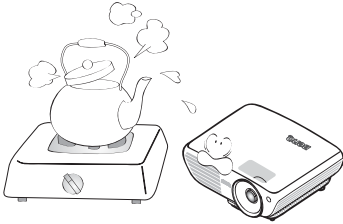

- Locations near fire alarms
- Locations with an ambient temperature above 40°C / 104°F
- Locations where the altitudes are higher than 3000 m (10000 feet).

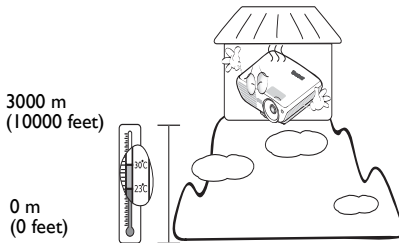

14. Do not block the ventilation holes.
- Do not place this projector on a blanket, bedding or any other soft surface.
 - Do not cover this projector with a cloth or any other item.
 - Do not place inflammables near the projector.

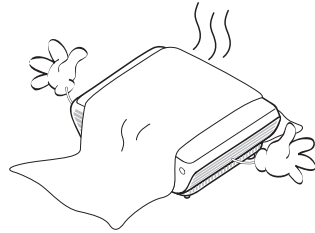

If the ventilation holes are seriously obstructed, overheating inside the projector may result in a fire.

15. Always place the projector on a level, horizontal surface during operation.
- Do not use if tilted at an angle of more than 10 degrees left to right, nor at angle of more than 15 degrees front to back. Using the projector when it is not fully horizontal may cause a malfunction of, or damage to, the lamp.

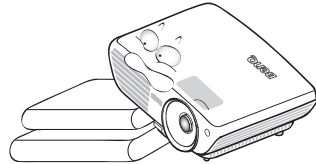

16. Do not stand the projector on end vertically. Doing so may cause the projector to fall over, causing injury or resulting in damage to the projector.

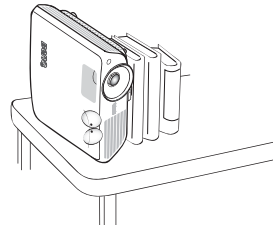

Safety Instructions (Continued)

17. Do not step on the projector or place any objects upon it. Besides probable physical damage to the projector, doing so may result in accidents and possible injury.

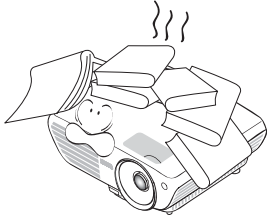

18. Do not place liquids near or on the projector. Liquids spilled into the projector may cause it to fail. If the projector does become wet, disconnect it from the power supply's wall socket and call BenQ to have the projector serviced.

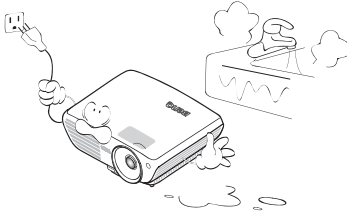

19. This product is capable of displaying inverted images for ceiling mount installation.



Use only BenQ's Ceiling Mount Kit for mounting the projector and ensure it is securely installed.

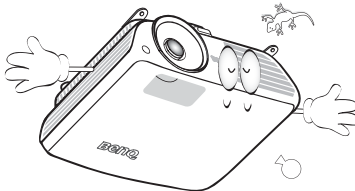

Ceiling mounting the projector

We want you to have a pleasant experience using your BenQ projector, so we need to bring this safety matter to your attention to prevent possible damage to person and property.

If you intend to mount your projector on the ceiling, we strongly recommend that you use a proper fitting BenQ projector ceiling mount kit and that you ensure it is securely and safely installed.

If you use a non-BenQ brand projector ceiling mount kit, there is a safety risk that the projector may fall from the ceiling due to an improper attachment through the use of the wrong gauge or length screws.

You can purchase a BenQ projector ceiling mount kit from the place you purchased your BenQ projector.

BenQ recommends that you also purchase a separate Kensington lock compatible security cable and attach it securely to both the Kensington lock slot on the projector and the base of the ceiling mount bracket. This will perform the secondary role of restraining the projector should its attachment to the mounting bracket become loose.



Hg - Lamp contains mercury. Manage in accordance with local disposal laws. See www.lamprecycle.org.

Projector features

- **Full HD compatible**
The projector is compatible with Standard Definition TV (SDTV) 480i, 576i, Enhanced Definition television (EDTV) 480p, 576p and High Definition TV (HDTV) 720p, 1080i/p 60Hz formats, with the 1080p format providing a true 1:1 image reproduction.
- **High picture quality**
The projector provides excellent picture quality due to its high resolution, excellent home theater brightness, high contrast ratio, vivid color and rich gray-scale reproduction.
- **High brightness**
The projector features super high brightness to achieve excellent picture quality in ambient light conditions, outperforming ordinary projectors.
- **Vivid color reproduction**
The projector features a 6-segment color wheel to produce realistic color depth and range unattainable with lesser segment color wheels.
- **Rich gray-scale**
When viewed in a darkened environment, the automatic gamma control provides excellent gray-scale display which reveals details in shadows and in night or darkened scenes.
- **Wide variety of inputs and video formats**
The projector supports a wide variety of inputs for connection to your video and PC equipment, including component video, S-Video, and composite video, as well as dual HDMI, PC, and an output trigger for connection to automated screen and environment lighting systems.
- **ISF certified calibration control**
To reach a higher standard of performance, the projector incorporates ISF NIGHT and ISF DAY mode settings in its OSD menus, which requires professional calibration service from authorized ISF installers.
- **3D function**
To enjoy the 3D movies, videos, and sporting events in a more realistic way by presenting the depth of the images through HDMI.
- **Built-in speaker(s)**
Built-in speaker(s) providing mixed mono audio when an audio input is connected.
- **Intuitive lens shift**
The intuitive control over lens shift lever provides flexibility in setting-up your projector.
- **SmartEco**
SmartEco™ technology saves lamp power consumption up to 70% depending on the content brightness level when SmartEco mode is selected.
- **SmartEco™ starts your dynamic power saving**
The SmartEco™ technology offers a new way of operating the projector lamp system and saves lamp power depending on the content brightness level.
- **Longest lamp life with SmartEco™ technology**
The SmartEco™ technology lowers the power consumption and increases the lamp life.

- **ECO BLANK saves the lamp power**

By pressing the ECO BLANK button to hide the image and immediately lower the lamp power at the same time.

Shipping contents

Carefully unpack and verify that you have all of the items shown below. If any of these items are missing, please contact your place of purchase.

Standard accessories

 The supplied accessories will be suitable for your region, and may differ from those illustrated.

*The warranty card is only supplied in some specific regions. Please consult your dealer for detailed information.

Europe sku doesn't have VGA cable in standard accessories.

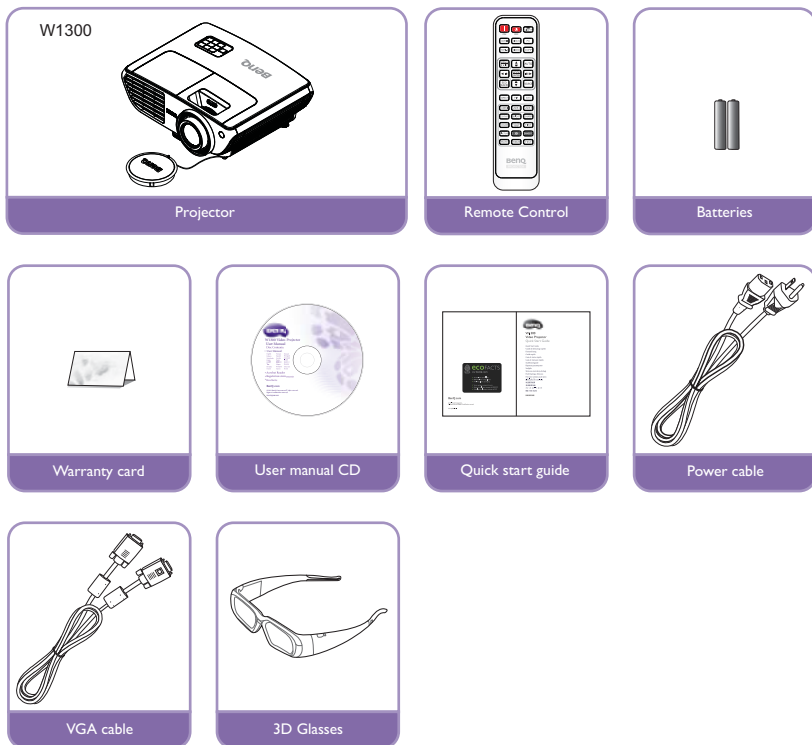

Optional accessories

1. Spare lamp kit
2. Ceiling mount kit
3. 3D Glasses
4. Carry bag

Projector exterior view

Front/upper side

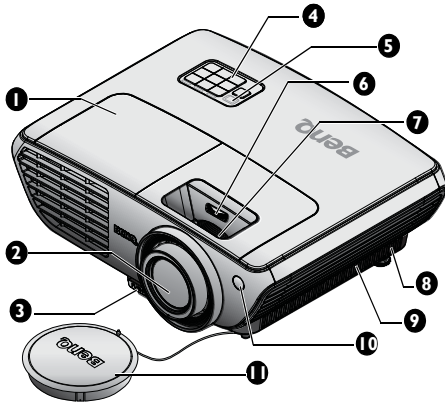

1. Lamp compartment cover
2. Projection lens
3. Quick-release button
4. External control panel
(See "Projector" on page 11 for details.)
5. Top IR remote sensor
6. Lens Shift
7. Focus ring and Zoom ring
8. Audio speaker
9. Vent (cool air intake)
10. Front IR remote sensor
11. Lens cap & string

Rear/lower side

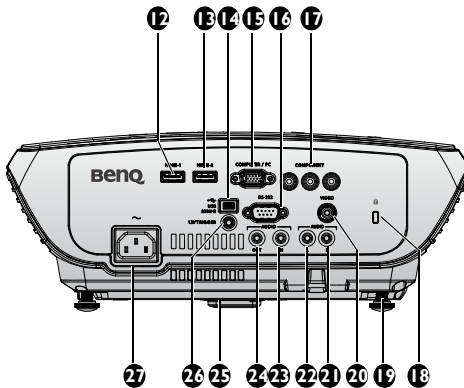

12. HDMI 1 input jack
13. HDMI 2 input jack
14. USB Mini B input jack
15. COMPUTER PC input jack
16. RS-232 control port
17. COMPONENT input jacks
18. Kensington anti-theft lock slot
19. Rear adjuster foot
20. VIDEO input jack
21. AUDIO input jack (R)
22. AUDIO input jack (L)
23. AUDIO input jack
24. AUDIO output jack
25. Quick-release foot
26. 12 V TRIGGER out jack
27. AC power cord inlet

Bottom side

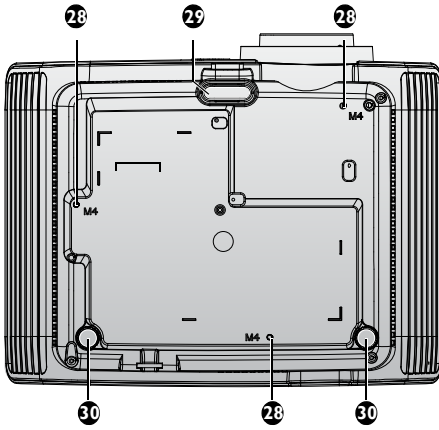

- 28. Ceiling mount holes
- 29. Front adjuster foot
- 30. Rear adjuster foot

Controls and functions

Projector

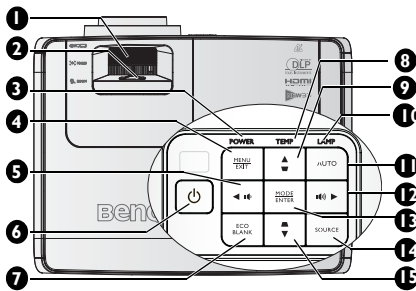

1. **FOCUS/ZOOM Ring**
Used to adjust the projected image appearance. See ["Fine-tuning the image size and clarity" on page 30](#) for details.
2. **LENS SHIFT adjuster**
Used to adjust the projector lens up or down. See ["Shifting the projection lens" on page 21](#) for details.
3. **POWER indicator light**
Lights up or flashes when the projector is under operation. See ["Indicators" on page 64](#) for details.
4. **MENU/EXIT**
Turns on the On-Screen Display (OSD) menu. Goes back to previous OSD menu, exits and saves menu settings. See ["Using the menus" on page 31](#) for details.
5. **◀ Left/ 🔊 Decrease volume level**
Decreases volume. See ["Adjusting the sound level" on page 42](#) for details.
6. **⏻ POWER**
Toggles the projector between standby mode and on.
See ["Starting up the projector" on page 28](#) and ["Shutting down the projector" on page 47](#) for details.
7. **ECO BLANK**
Used to hide the screen picture.
8. **TEMPerature indicator light**
Lights up red if the projector's temperature becomes too high. See ["Indicators" on page 64](#) for details.
9. **Keystone/Arrow keys (▽ / ▲ Up)**
Manually corrects distorted images resulting from an angled projection. See ["Correcting keystone" on page 30](#) for details.
10. **LAMP indicator light**
Indicates the status of the lamp. Lights up or flashes when the lamp has developed a problem. See ["Indicators" on page 64](#) for details.
11. **AUTO**
Automatically determines the best picture timings for the displayed image. See ["Auto-adjusting the image" on page 29](#) for details.
12. **▶ Right/ 🔊 Increase volume level**
Increases volume. See ["Adjusting the sound level" on page 42](#) for details.
When the On-Screen Display (OSD) menu is activated, the #5, #9, #12, and #15 keys are used as directional arrows to select the desired menu items and to make adjustments. See ["Using the menus" on page 31](#) for details.
13. **MODE/ENTER**
Selects an available picture setup mode. Enacts the selected On-Screen Display (OSD) menu item. See ["Using the menus" on page 31](#) for details.
14. **SOURCE**
Displays the source selection bar. See ["Switching input signal" on page 35](#) for details.
15. **Keystone/Arrow keys (▲ / ▼ Down)**
Manually corrects distorted images resulting from an angled projection. See ["Correcting keystone" on page 30](#) for details.

Remote control

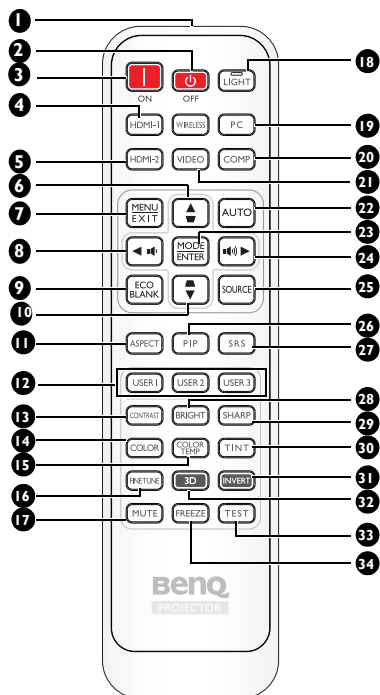

1. **IR transmitter**
Transmits signal to projector.
2. **POWER OFF**
Turns off the projector. See ["Shutting down the projector" on page 47](#) for details.
3. **POWER ON**
Turns on the projector. See ["Starting up the projector" on page 28](#) for details.
4. **HDMI 1**
Displays the HDMI 1 source selection. See ["Switching input signal" on page 35](#) for details.
5. **HDMI 2**
Displays the HDMI 2 source selection. See ["Switching input signal" on page 35](#) for details.

6. Up cursor/Keystone (▲/▼)

▲: Navigates and changes settings in the OSD. See ["Using the menus" on page 31](#) for details.

▼: Manually corrects distorted images resulting from an angled projection. See ["Correcting keystone" on page 30](#) for details.

7. MENU/ EXIT

MENU: Turns on the On-Screen Display (OSD) menu.

EXIT: Goes back to previous OSD menu, exits and saves menu settings.

See ["Using the menus" on page 31](#) for details.

8. Left cursor/Decrease volume level (◀/▶)

◀: Navigates and changes settings in the OSD. See ["Using the menus" on page 31](#) for details.

▶: Decreases volume.

9. ECO BLANK

Hides the screen picture.

10. Down cursor/Keystone (▼/▲)

▼: Navigates and changes settings in the OSD. See ["Using the menus" on page 31](#) for details.

▲: Manually corrects distorted images resulting from an angled projection. See ["Correcting keystone" on page 30](#) for details.

11. ASPECT

Select the display aspect ratios. See ["Selecting the aspect ratio" on page 43](#) for details.

12. USER 1/ User 2/ User 3

Select the User memory settings.



Note: User 3 not supported for this model.

- 13. CONTRAST**
Displays the CONTRAST setting bar. See ["Adjusting Contrast" on page 38](#) for details.
- 14. COLOR**
Displays the COLOR setting bar. See ["Adjusting Color" on page 38](#) for details.
- 15. COLOR TEMP**
Displays the Color Temperature setting bar. See ["Selecting a Color Temperature" on page 39](#) for details.
- 16. FINE TUNE**
Displays the Color Temperature Fine Tune setting bar. See ["Setting a preferred color temperature" on page 40](#) for details.
- 17. MUTE**
Mutes the built-in speaker.
- 18. LIGHT**
Turns on or off the remote control backlight for about 10 seconds. Pressing any other key while the backlight is on keeps the backlight on for a further 10 seconds.
- 19. PC**
Displays the PC source selection. See ["Switching input signal" on page 35](#) for details.
- 20. COMP**
Displays the COMPONENT source selection. See ["Switching input signal" on page 35](#) for details.
- 21. VIDEO**
Displays the VIDEO source selection. See ["Switching input signal" on page 35](#) for details.
- 22. AUTO**
Automatically determines the best picture timings for the displayed image.
- 23. MODE/ ENTER**
MODE: Choose a suitable preset mode for usage environment.
ENTER: Enter key for OSD menu.
- 24. Right cursor/Increase volume level**
(▶ / 🔊)
▶ : Navigates and changes settings in the OSD. See ["Using the menus" on page 31](#) for details.
🔊 : Increase Volume.
- 25. SOURCE**
Displays the source selection bar.
- 26. PIP**
Enables the PIP function. Use the ▲ / ▼ / ◀ / ▶ keys to adjust the position of the PIP window
- 27. SRS**
Turns on/off the SRS (Sound Retrieval System) surround sound effects.
- 28. BRIGHT**
Displays the Brightness setting bar. See ["Adjusting Brightness" on page 38](#) for details.
- 29. SHARP**
Displays the Sharpness setting bar. See ["Adjusting Sharpness" on page 38](#) for details.
- 30. TINT**
Displays the Tint setting bar. See ["Adjusting Tint" on page 38](#) for details.
- 31. INVERT**
Set 3D Sync Invert to Disable or Invert.
- 32. 3D**
Displays the 3D setting bar.
- 33. TEST**
Displays the test pattern.
- 34. FREEZE**
Freeze/unfreezes the on-screen picture. See ["Freezing the image" on page 47](#) for details.

Remote control effective range

Infra-Red (IR) remote control sensor is located on the front and the top of the projector. The remote control must be held at an angle within 60 degrees perpendicular to the projector's IR remote control sensor to function correctly. The distance between the remote control and the sensor should not exceed 8 meters (~ 26 feet).

Make sure that there are no obstacles between the remote control and the IR sensor on the projector that might obstruct the infra-red beam.

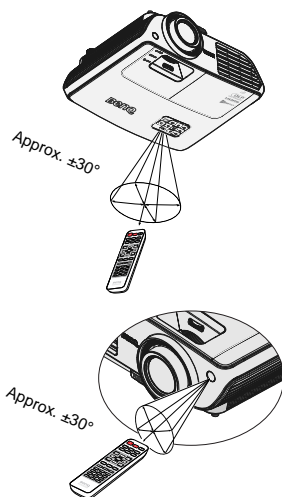

Replacing the remote control battery

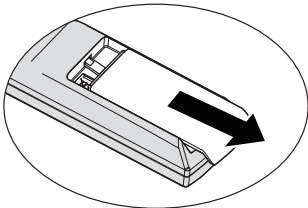
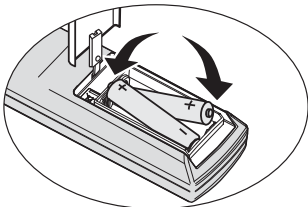
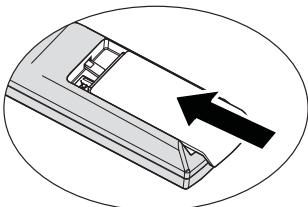
<p>1. Remove the battery compartment cover by sliding the cover in the direction of the arrow.</p>	
<p>2. Insert the supplied batteries taking note of the polarity (+/-) as shown here.</p>	
<p>3. Replace the cover.</p>	



- **Avoid excessive heat and humidity.**
- **There may be battery damage if the battery is incorrectly replaced.**
- **Replace only with the same or equivalent type recommended by the battery manufacturer.**
- **Dispose of the used battery according to the battery manufacturer's instructions.**
- **Never throw a battery into a fire. There may be danger of an explosion.**
- **If the battery is dead or if you will not be using the remote control for a long time, remove the battery to prevent damage to the remote control from possible battery leakage.**

Positioning your projector

Choosing a location

Your projector is designed to be installed in one of four possible installation locations.

Your room layout or personal preference will dictate which installation location you select. Take into consideration the size and position of your screen, the location of a suitable power outlet, as well as the location and distance between the projector and the rest of your equipment.

1. Front

Select this location with the projector placed on a table in front of the screen. This is the most common way to position the projector for quick setup and portability.

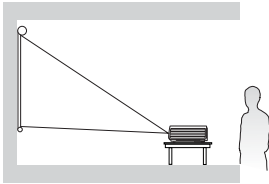

2. Rear

Select this location with the projector placed on a table behind the screen.

Note that a special rear projection screen is required.

*Set **Rear** after you turn the projector on.

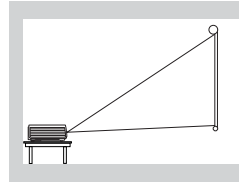

3. Front Ceiling

Select this location with the projector suspended upside-down from the ceiling in front of the screen.

Purchase the BenQ Projector Ceiling Mounting Kit from your dealer to mount your projector on the ceiling.

*Set **Front Ceiling** after you turn the projector on.

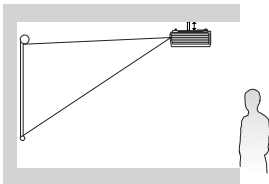

4. Rear Ceiling

Select this location with the projector suspended upside-down from the ceiling behind the screen.

Note that a special rear projection screen and the BenQ Projector Ceiling Mounting Kit are required for this installation location.

*Set **Rear Ceiling** after you turn the projector on.

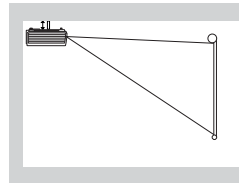

*To set the projector position:

1. Press **MENU/EXIT** on the projector or remote control and then press **◀/▶** until the system **System Setup: Basic** menu is highlighted.
2. Press **▲/▼** to highlight **Projector** and press **◀/▶** until the correct position is selected.

Obtaining a preferred projected image size

The distance from the projector lens to the screen, the zoom setting (if available), and the video format each factors in the projected image size.

The projector should always be placed horizontally level (like flat on a table), and positioned directly perpendicular (90° right-angle square) to the horizontal center of the screen. This prevents image distortion caused by angled projections (or projecting onto angled surfaces).

If the projector is mounted on a ceiling, it must be mounted upside-down so that it projects at a slightly downward angle.

If the projector is positioned further away from the screen, the projected image size increases, and the vertical offset also increases proportionately.

When determining the position of the screen and projector, you will need to account for both the projected image size and the vertical offset dimension, which are directly proportional to the projection distance.

How to determine the position of the projector for a given screen size

1. Refer to the table and find the closest match to your screen size in the left columns labelled "Screen dimensions" on page 19. Using this value, look across this row to the right to find the corresponding average distance from screen value in the column labelled "avg" on page 19. This is the projection distance.
2. Decide the exact position of your projector according to the position of your screen and the adjustable lens shift range.

How to determine the recommended screen size for a given distance

This method can be used for situations where you have purchased this projector and would like to know what screen size will fit in your room.

The maximum screen size is limited by the physical space available in your room.

1. Measure the distance between the projector and where you want to position the screen. This is the projection distance.
2. Refer to the table and find the closest match to your measurement in the average distance from screen column labelled "avg" on page 19. Check that your measured distance is between the min and max distances listed on either side of the average distance value.
3. Using this value, look across that row to the left to find the corresponding screen diagonal listed in that row. That is the projected image size of the projector at that projection distance.

For example,

if you have a 16:9 aspect ratio screen and your measured projection distance was 5.0 m (5000 mm), the closest match in the ["avg" on page 19](#) column is 5008 mm. Looking across this row shows that a 130-inch screen is required.

Checking the min. projection distance in the columns of ["Projection distance <D> \[mm\]" on page 19](#) indicates that the 5000 mm measured projection distance will also fit the 110 and 160-inch size screens. The projector can be adjusted (using the zoom control) to display on these different screen sizes at the projection distance. Be aware that these different screens have different vertical offset values.

If you place the projector in a different position (to that recommended), you will have to tilt it down or up to center the image on the screen. In these situations, some image distortion will occur. Use the Keystone function to correct the distortion. See ["Correcting keystone" on page 30](#) for details.

Projection dimensions

Refer to "Dimensions" on page 67 for the center of lens dimensions of this projector before calculating the appropriate position.

Floor Installation

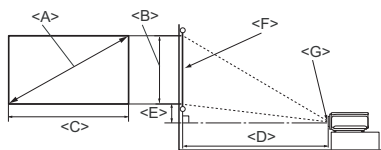

<F>: Screen <G>: Center of lens

Ceiling Installation

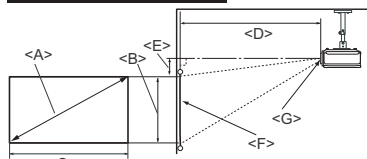

<F>: Screen <G>: Center of lens

Screen dimensions			Projection distance <D> [mm]			Lowest/Highest lens position <E> [mm]	
Diagonal <A> [inch (mm)]	Height [mm]	Width <C> [mm]	Min distance (with max zoom)	avg	Min distance (with min zoom)	(min.)	(max.)
			26 (659)	323	574	-	-
30 (762)	374	664	923	1156	1388	37	90
40 (1016)	498	886	1231	1541	1851	50	120
50 (1270)	623	1107	1539	1926	2313	62	149
60 (1524)	747	1328	1846	2311	2776	75	179
70 (1778)	872	1550	2154	2696	3239	87	209
80 (2032)	996	1771	2462	3082	3701	100	239
90 (2286)	1121	1992	2769	3467	4164	112	269
100 (2540)	1245	2214	3077	3852	4627	125	299
110 (2794)	1370	2435	3385	4237	5090	137	329
120 (3048)	1494	2657	3693	4622	5552	149	359
130 (3302)	1619	2878	4000	5008	6015	162	389
140 (3556)	1743	3099	4308	5393	6478	174	418
150 (3810)	1868	3321	4616	5778	6940	187	448
160 (4064)	1992	3542	4923	6163	7403	199	478
170 (4318)	2117	3763	5231	6548	7866	212	508
180 (4572)	2241	3985	5539	6934	8328	224	538
190 (4826)	2366	4206	5847	7319	8791	237	568
200 (5080)	2491	4428	6154	7704	9254	249	598

Screen dimensions			Projection distance <D> [mm]			Lowest/Highest lens position <E> [mm]	
Diagonal <A> [inch (mm)]	Height [mm]	Width <C> [mm]	Min distance (with max zoom)	avg	Min distance (with min zoom)	(min.)	(max.)
			250 (6350)	3113	5535	7693	9630
300 (7620)	3736	6641	9232	11556	13881	374	897
325 (8254)	4047	7194	10000	-	-	405	971

 There is 5% tolerance among these numbers due to optical component variations. BenQ recommends that if you intend to permanently install the projector, you should physically test the projection size and distance using the actual projector before you permanently install it, so as to make allowance for this projector's optical characteristics. This will help you determine the exact mounting position so that it best suits your installation location.

Shifting the projection lens

The lens shift control provides flexibility for installing your projector. It allows the projector to be positioned off the center of the screen.

The lens shift is expressed as a percentage of the projected image half height. It is measured as an offset from the projected image's vertical center. You can shift the projection lens within the allowable range depending on your desired image position.

- **When the screen position is fixed**

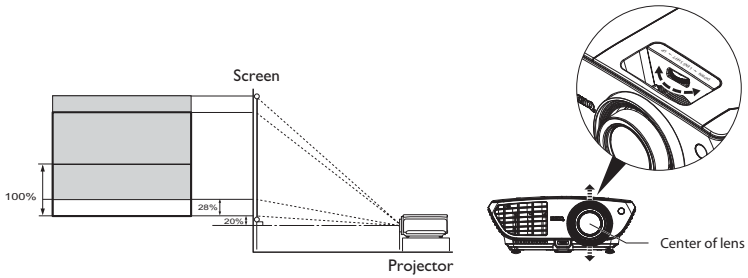

- **When the projector position is fixed**

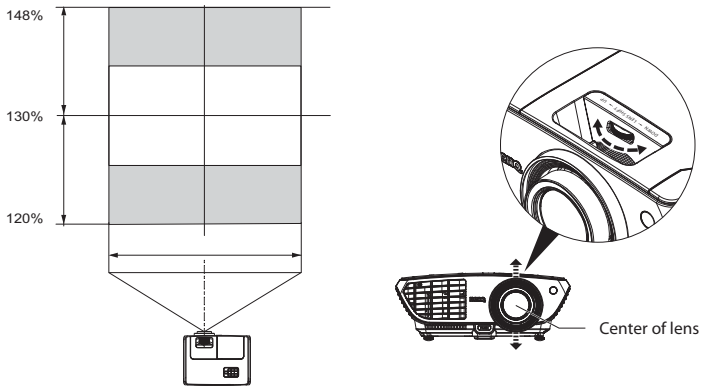

 Lens shift adjustment will not result in a degraded picture quality. In the unlikely event that the image distortion is produced, see ["Correcting keystone" on page 30](#) for details.

Connection

When connecting a signal source to the projector, be sure to:

1. Turn all equipment off before making any connections.
2. Use the correct signal cables for each source.
3. Ensure the cables are firmly inserted.

- ☞ In the connections shown below, some cables may not be included with the projector (see "Shipping contents" on page 8). They are commercially available from electronics stores.
- The connection illustrations below are for reference only. The rear connecting jacks available on the projector vary with each projector model.

HDMI connection

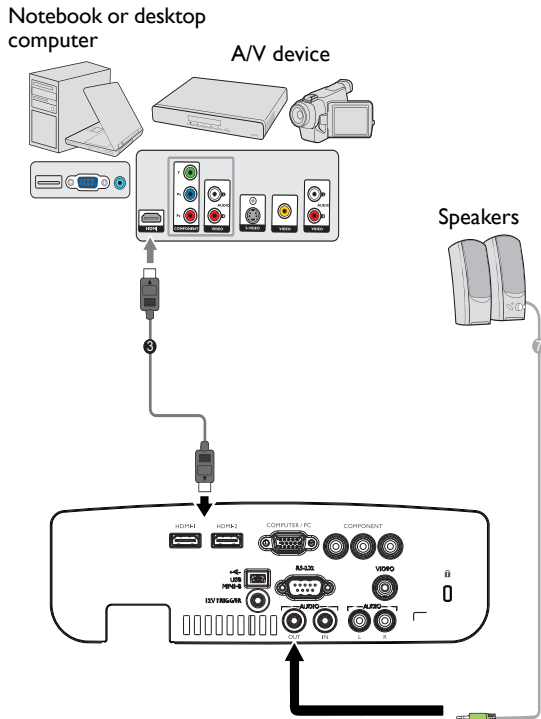

3. HDMI cable

7. Audio cable

Component Video connection

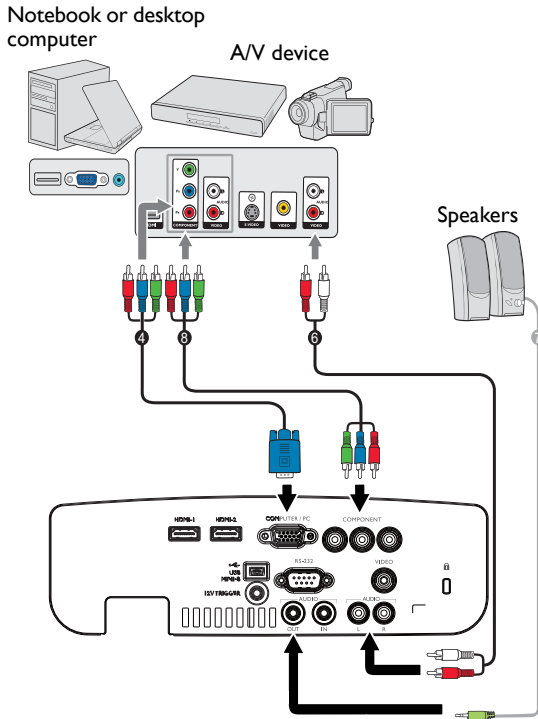

- | | |
|---|---|
| <ul style="list-style-type: none"> 4. Component Video to VGA (D-Sub) adapter cable 6. Audio L/R cable | <ul style="list-style-type: none"> 7. Audio cable 8. Component Video to Component cable |
|---|---|

Video connection

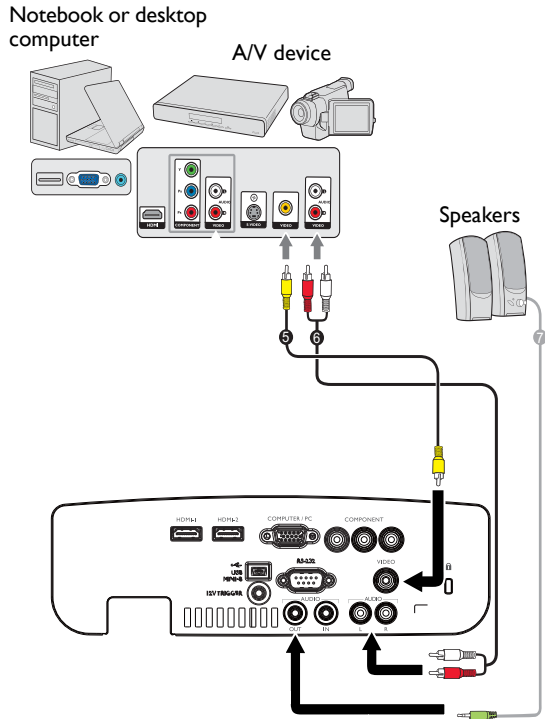

- 5. Video cable
- 6. Audio L/R cable

- 7. Audio cable

Computer/PC connection

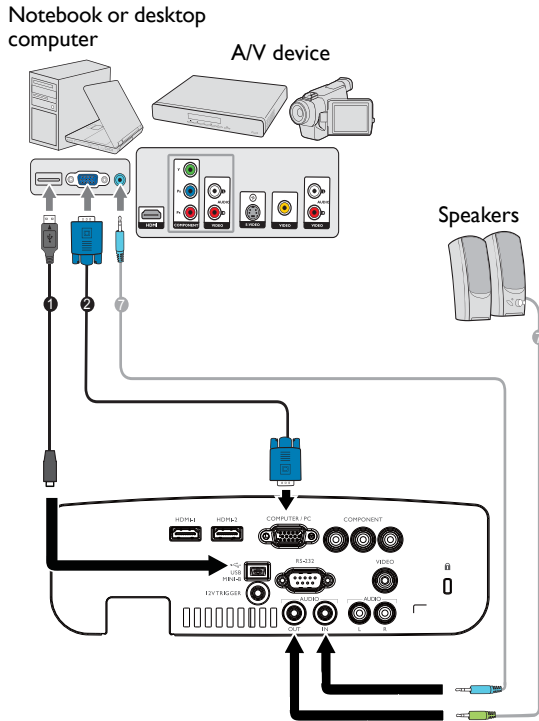





1. USB cable
2. VGA cable

7. Audio cable

☞ • **Many notebooks do not turn on their external video ports when connected to a projector. Usually a key combo like FN + F3 or CRT/LCD key turns the external display on/off. Locate a function key labeled CRT/LCD or a function key with a monitor symbol on the notebook. Press FN and the labeled function key simultaneously. Refer to your notebook's documentation to find your notebook's key combination.**

Connecting video source devices

You need only connect the projector to a video source device using just one of the connecting methods, however each provides a different level of video quality. The method you choose will most likely depend upon the availability of matching terminals on both the projector and the video source device as described below:

Terminal name	Terminal appearance	Picture quality
HDMI		Best
Component Video		Better
PC		Better
Video		Normal

Connecting audio

The projector has one built-in mono speaker which are designed to provide basic audio functionality accompanying data presentations for business purposes only. They are not designed for, nor intended for stereo audio reproduction use as might be expected in home theater or home cinema applications. Any stereo audio input (if provided), is mixed into a common mono audio output through the projector speaker.

The built-in speaker will be muted when the **AUDIO OUT** jack is connected.

-  • **The projector is only capable of playing mixed mono audio, even if a stereo audio input is connected. See "Connecting audio" on page 26 for details.**
- **If the selected video image is not displayed after the projector is turned on and the correct video source has been selected, check that the video source device is turned on and operating correctly. Also check that the signal cables have been connected correctly.**

Playing sound through the projector

You can make use of the projector (mixed mono) speaker in your presentations, and also connect separate amplified speakers to the AUDIO OUT socket of the projector.

If you have a separate sound system, you will most likely want to connect the audio output of your Video source device to that sound system, instead of to the mono audio projector.

Once connected, the audio can be controlled by the projector On-Screen Display (OSD) menus.

The table below describes the connection methods for different devices, and where the sound is from.

Device	Computer/PC	Component/Video	HDMI 1/2
Audio input port	AUDIO IN (mini jack)	AUDIO (L/R)	HDMI
The projector can play the sound from...	AUDIO IN (mini jack)	AUDIO (L/R)	HDMI
Audio output port	AUDIO OUT	AUDIO OUT	AUDIO OUT

The selected input signal determines which sound will be played by the projector speaker, and which sound will be output from the projector when AUDIO OUT is connected. If you select the COMPUTER/PC signal, the projector can play the sound received from AUDIO IN mini jack. If you select the COMPONENT/VIDEO signal, the projector can play the sound received from AUDIO (L/R).

Operation

Starting up the projector

1. Plug the power cord into the projector and into a wall socket. Turn on the wall socket switch (where fitted). Check that the **POWER indicator light** on the projector lights orange after power has been applied.

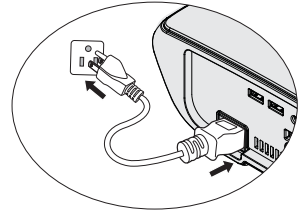

 **Please use the original accessories (e.g. power cable) only with the device to avoid possible dangers such as electric shock and fire.**

2. Press **POWER** on the projector  or remote control  to start the projector and a start up tone sounds. The **POWER indicator light** flashes green and stays green when the projector is on.

The start up procedure takes about 30 seconds. In the later stage of start up, a startup logo is projected.

(If necessary) Rotate the focus ring to adjust the image clearness.

To turn off the ring tone, see "[Turning off the Power on/off ring tone](#)" on page 43 for details.

 **If the projector is still hot from previous activity, it will run the cooling fan for approximately 90 seconds before energizing the lamp.**

3. To use the OSD menus, please set them to your familiar language first. See "[Personalizing the projector menu display](#)" on page 45 for details.
 4. If you are prompted for a password, press the arrow keys to enter a five digit password. See "[Utilizing the password function](#)" on page 32 for details.
 5. Switch all of the connected equipment on.
 6. The projector will start to search for input signals. The current input signal being scanned displays in the upper left corner of the screen. If the projector doesn't detect a valid signal, the message '**No Signal**' will continue displaying until an input signal is found.
- You can also press **SOURCE** on the projector or remote control to select your desired input signal. See "[Switching input signal](#)" on page 35 for details.



 **If the frequency/resolution of the input signal exceeds the projector's operating range, you will see the message 'Out of Range' displayed on a blank screen. Please change to an input signal which is compatible with the projector's resolution or set the input signal to a lower setting. See "[Timing chart](#)" on page 68 for details.**

Adjusting the projected image

Adjusting the projection angle

The projector is equipped with 1 quick-release adjuster foot and 2 rear adjuster foot. These adjusters change the image height and projection angle. To adjust the projector:

1. Press the quick-release button and lift the front of the projector. Once the image is positioned where you want it, release the quick-release button to lock the foot in position.
2. Screw the rear adjuster foot to fine tune the horizontal angle.

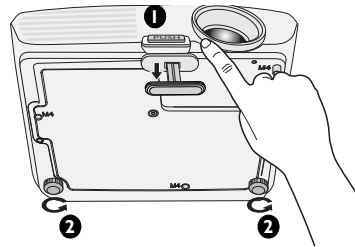

To retract the foot, hold up the projector while pressing the quick-release button, then slowly lower the projector. Screw the rear adjuster foot in a reverse direction.

If the projector is not placed on a flat surface or the screen and the projector are not perpendicular to each other, the projected image becomes trapezoidal. To correct this situation, see "[Correcting keystone](#)" on page 30 for details.

- ⚠ • **Do not look into the lens while the lamp is on. The strong light from the lamp may cause damage to your eyes.**
- **Be careful when you press the adjuster button as it is close to the exhaust vent where hot air comes from.**

Auto-adjusting the image

In some cases, you may need to optimize the picture quality. To do this, press **AUTO** on the projector or remote control. Within 3 seconds, the built-in Intelligent Auto Adjustment function will re-adjust the values of Frequency and Clock to provide the best picture quality.

The current source information will be displayed in the upper left corner of the screen for 3 seconds.

- ☞ • **The screen will be blank while **AUTO** is functioning.**
- **This function is only available when PC signal (analog RGB) is selected.**

Fine-tuning the image size and clarity

1. Adjust the projected image to the size that you need using the ZOOM ring.

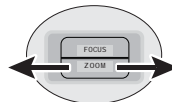
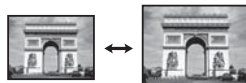

2. Then sharpen the image by rotating the FOCUS ring.

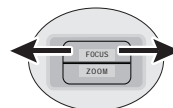
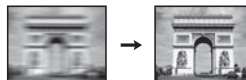

Correcting keystone

Keystoning refers to the situation where the projected image is noticeably wider at either the top or bottom. It occurs when the projector is not perpendicular to the screen.

To correct this, besides adjusting the height of the projector, you can use **Keystone** manually correct it following one of these steps.

1. Press **MENU/EXIT** and then press ◀ / ▶ until the **Display** menu is highlighted.
2. Press ▼ to highlight **Keystone** and press **MODE/ENTER**. The **Keystone** correction page displays.
3. Press ▲ to correct keystone at the top of the image or press ▼ to correct keystone at the bottom of the image.



Press ▼ / ▼.

Press ▲ / ▲.



Using the menus

The projector is equipped with On-Screen Display (OSD) menus for making various adjustments and settings.

Below is the overview of the OSD menu.

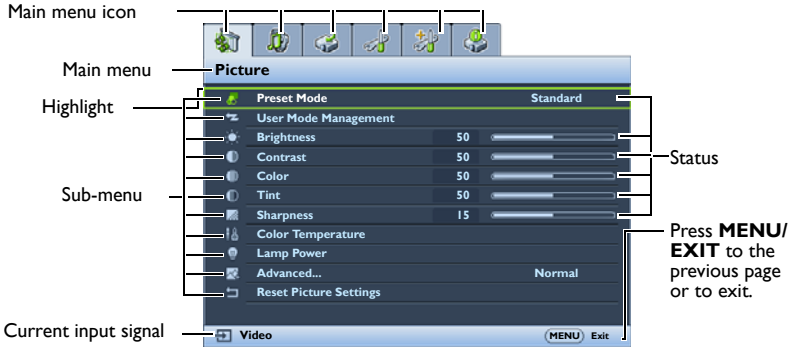

To use the OSD menus, please set them to your familiar language first.

1. Press **MODE/ENTER** on the projector or remote control to turn the OSD menu on.
3. Press **▼** to highlight **Language** and press **◀/▶** to select a preferred language.



2. Use **◀/▶** to highlight the **System Setup: Basic** menu.
4. Press **MODE/ENTER** twice* on the projector or remote control to leave and save the settings.



*The first press leads you back to the main menu and the second press closes the OSD menu.

Securing the projector

Using a security cable lock

The projector has to be installed in a safe place to prevent theft. Otherwise, purchase a lock, such as a Kensington lock, to secure the projector. You can locate a Kensington lock slot on the left side of the projector. See "[Kensington anti-theft lock slot](#)" on [page 9](#) for details.

A Kensington security cable lock is usually a combination of key(s) and a lock. Refer to the lock's documentation for finding out how to use it.

Utilizing the password function

For security purposes and to help prevent unauthorized use, the projector includes an option for setting up password security. The password can be set through the On-Screen Display (OSD) menu. For details of the OSD menu operation, please refer to "[Using the menus](#)" on [page 31](#).

 **You will be inconvenienced if you activate the power-on lock functionality and subsequently forget the password. Print out this manual (if necessary) and write the password you used in this manual, and keep the manual in a safe place for later recall.**

Setting a password

 **Once a password has been set, the projector cannot be used unless the correct password is entered every time the projector is started.**

1. Open the OSD menu and go to the **System Setup: Advanced > Password** menu. Press **MODE/ENTER**. The **Password** page displays.
2. Highlight **Power on Lock** and select **On** by pressing **◀/▶**.
3. As pictured to the right, the four arrow keys (**▲**, **▼**, **◀**, **▶**) respectively represent 4 digits (1, 2, 3, 4). According to the password you desire to set, press the arrow keys to enter five digits for the password.
4. Confirm the new password by re-entering the new password.
Once the password is set, the OSD menu returns to the **Password** page.
5. To activate the **Power on Lock** function, press **▲/▼** to highlight **Power on Lock** and press **◀/▶** to select **On**.



 **The digits being input will display as asterisks on-screen. Write your selected password down here in this manual in advance or right after the password is entered so that it is available to you should you ever forget it.**

Password: _____

Keep this manual in a safe place.

6. To leave the OSD menu, press **MENU/EXIT**.

If you forget the password

If the password function is activated, you will be asked to enter the five-digit password every time you turn on the projector. If you enter the wrong password, the password error message as pictured to the right displays lasting for three seconds, and the message **'INPUT PASSWORD'** follows. You can retry by entering another five-digit password, or if you did not record the password in this manual, and you absolutely do not remember it, you can use the password recall procedure. See ["Entering the password recall procedure" on page 33](#) for details.

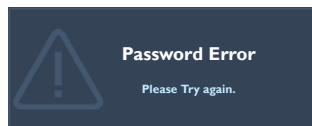

If you enter an incorrect password 5 times in succession, the projector will automatically shut down in a short time.

Entering the password recall procedure

1. Press and hold **AUTO** on the projector or remote control for 3 seconds. The projector will display a coded number on the screen.
2. Write down the number and turn off your projector.
3. Seek help from the local BenQ service center to decode the number. You may be required to provide proof of purchase documentation to verify that you are an authorized user of the projector.

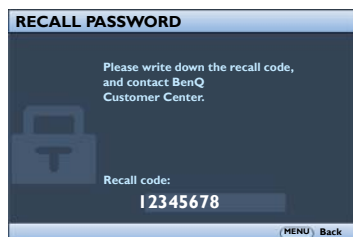

Changing the password

1. Open the OSD menu and go to the **System Setup: Advanced > Password > Change password** menu.
2. Press **MODE/ENTER**. The message **'INPUT CURRENT PASSWORD'** displays.
3. Enter the old password.
 - If the password is correct, another message **'INPUT NEW PASSWORD'** displays.
 - If the password is incorrect, the password error message displays lasting for three seconds, and the message **'INPUT CURRENT PASSWORD'** displays for your retry. You can press **MENU/EXIT** to cancel the change or try another password.
4. Enter a new password.

 The digits being input will display as asterisks on-screen. Write your selected password down here in this manual in advance or right after the password is entered so that it is available to you should you ever forget it.

Password: _ _ _ _ _

Keep this manual in a safe place.

5. Confirm the new password by re-entering the new password.
6. You have successfully assigned a new password to the projector. Remember to enter the new password next time the projector is started.

7. To leave the OSD menu, press **MENU/EXIT**.

Disabling the password function

To disable password protection, go back to the **System Setup: Advanced > Password > Power on Lock** menu after opening the OSD menu system. Select **Off** by pressing **◀/▶**. The message '**INPUT PASSWORD**' displays. Enter the current password.

- i. If the password is correct, the OSD menu returns to the **Password** page with **Off** show in the row of **Power on Lock**. You will not have to enter the password next time you turn on the projector.
- ii. If the password is incorrect, the password error message displays lasting for three seconds, and the message '**INPUT PASSWORD**' displays for your retry. You can press **MENU/EXIT** to cancel the change or try another password.

 **Though the password function is disabled, you need to keep the old password in hand should you ever need to re-activate the password function by entering the old password.**

Switching input signal

The projector can be connected to multiple devices at the same time. However, it can only display one full screen at a time.

You can also manually cycle through the available input signals.

1. Press **SOURCE** on the projector or press input source directly from the remote control. A source selection bar displays.
2. Press **▲/▼** until your desired signal is selected and press **MODE/ENTER**. Once detected, the selected source information will display on the screen for seconds. If there is multiple equipment connected to the projector, repeat steps 1-2 to search for another signal.



- **The brightness level of the projected image will change accordingly when you switch between different input signals. Data (graphic) "PC" presentations using mostly static images are generally brighter than "Video" using mostly moving images (movies).**
- **The native display resolution of this projector is in a 16:9 aspect ratio. For best display picture results, you should select and use an input signal which outputs at this resolution. Any other resolutions will be scaled by the projector depending upon the 'aspect ratio' setting, which may cause some image distortion or loss of picture clarity. See "Selecting the aspect ratio" on page 43 for details.**

You can also rename the source:

1. Press **MENU/EXIT** and then press **◀/▶** until the **System Setup: Basic** menu is highlighted.
 2. Press **▼** to highlight **Source Rename** and press **MODE/ENTER**. The **Source Rename** page displays.
 3. Press **▲/▼/◀/▶** until your desired character is selected and press **MODE/ENTER**.
- If you want the projector to automatically search for the signals, select **On** in the **System Setup: Basic > Auto Source Search** menu.

Using the preset and user modes

Selecting a preset mode

The projector is preset with several pre-defined picture modes so that you can choose one to suit your operating environment and input source picture type.

To select a preset mode that suits your need:

1. Press **MENU/EXIT** and then press ◀/▶ until the **Picture** menu is highlighted.
2. Press ▼ to highlight **Preset Mode**.
3. Press ◀/▶ until your desired mode is selected.

These modes consist of preset values suitable for various projection situations as described below:

- **Cinema:** With well-balanced color saturation and contrast with a low brightness level, this is most suitable for enjoying movies in a totally dark environment (as you would find in a commercial cinema).
- **Dynamic:** Maximizes the brightness of the projected image. This mode is suitable for environments where extra-high brightness is required, such as using the projector in well lit rooms.
- **Standard:** It is slightly brighter than **Cinema** mode, and suitable for use in rooms where there is a small amount of ambient light.
- **3D:** It is optimized to bring up 3D effects when watching 3D contents.

 **This mode is only available when 3D function is enabled.**

- **User 1/User 2/User 3:** Recalls the customized settings. See "[Setting the User 1/User 2/User 3 mode](#)" on page 37 for details.

 **User 3 is only available when 3D mode is enabled.**

Fine-tuning the selected picture mode

The pre-defined picture mode settings can be altered via the available items shown in the Picture menus.

To fine-tune the picture mode:

1. Press **MENU/EXIT** and then press ◀/▶ until the **Picture** menu is highlighted.
2. Press ▼ to highlight the item you want to adjust and press ◀/▶ to set your desired value. Your selection is automatically stored in the projector and associated with that input source.

See "[Fine-tuning the selected picture mode](#)" on page 36 and "[Advanced picture quality controls](#)" on page 39 for details.

Each time you change the picture mode, the projector also changes the setting to the one which was last set for that particular picture mode on that particular input. If you change the input source, the most recently used picture mode and settings for that input and resolution will be restored.

Setting the User 1/User 2/User 3 mode

There are three user-definable modes if the current available picture modes are not suitable for your need. You can use one of the picture modes (except the selected User mode) as a starting point and customize the settings.

1. In the **Picture** menu, highlight **Preset Mode** and press ◀/▶ to select **User 1**, **User 2**, or **User 3** mode.
2. Press ▼ to highlight **User Mode Management**.

 This function is only available when **User 1**, **User 2**, or **User 3** mode is selected up in the **Preset Mode** sub-menu item.

3. Press **MODE/ENTER** to display the **User Mode Management** page.
4. Press ▼ to highlight **Reference Mode** and press **MODE/ENTER**.
5. Press ▼ to highlight a picture mode that is closest to your need and press **MODE/ENTER** and **MENU/EXIT** to go back to the **User Mode Management** page.
6. Here you can rename the **User 1**, **User 2**, or **User 3** mode by press to highlight **Rename User Mode** and press **MODE/ENTER**. The **Rename User Mode** page displays.
7. Press ▲/▼/◀/▶ until your desired character is selected and press **MODE/ENTER**.
8. Press **MENU/EXIT** to go back to the main menu once you are done.
9. Press ▼ to select a sub-menu item to be changed and adjust the value with ◀/▶ . See "[Fine-tuning the selected picture mode](#)" on page 36 and "[Advanced picture quality controls](#)" on page 39 for details.
10. When all settings have been done, press **MENU/EXIT** to save and leave the settings.

Resetting the picture mode

All of the adjustments you've done in the **Picture** menus can be returned to the factory preset values with a key press on the highlight of **Reset**.

To reset the picture mode to the preset factory values:

1. In the **Picture** menu, highlight **Preset Mode** and press ◀/▶ to select the picture mode (including **User 1**, **User 2**, or **User 3**) you want to reset.
2. Press ▼ to highlight **Reset Picture Settings** and press **MODE/ENTER**. The confirmation message displays.
3. Press ◀/▶ to highlight **Reset** and press **MODE/ENTER**. The picture mode will return to the factory preset settings.
4. Repeat steps 1-3 if you want to reset other picture modes.

 Do not to be confused with the **Reset Picture Settings** function here with the **Reset All Settings** in the **System Setup : Advanced** menu. The **Reset All Settings** function returns most of the settings to the factory preset values system wide. See "[Reset All Settings](#)" on page 56 for details.

Fine-tuning the image quality in user modes

According to the detected signal type, there are some user-definable functions available when **User 1** or **User 2** mode is selected. You can make adjustments to these functions based on your needs.

Adjusting Brightness

Highlight **Brightness** in the **Picture** menu and adjust the values by pressing ◀/▶ on the projector or remote control.

The higher the value, the brighter the image. And lower the setting, darker the image. Adjust this control so the black areas of the image appear just as black and that detail in the dark areas is visible.



Adjusting Contrast

Highlight **Contrast** in the **Picture** menu and adjust the values by pressing ◀/▶ on the projector or remote control.

The higher the value, the greater the contrast. Use this to set the peak white level after you have previously adjusted the **Brightness** setting to suit your selected input and viewing environment.



Adjusting Color

Highlight **Color** in the **Picture** menu and adjust the values by pressing ◀/▶ on the projector or remote control.

Lower setting produces less saturated colors. If the setting is too high, colors on the image will be overpowering, which makes the image unrealistic.

Adjusting Tint

Highlight **Tint** in the **Picture** menu and adjust the values by pressing ◀/▶ on the projector or remote control.

The higher the value, the more reddish the picture becomes. The lower the value, the more greenish the picture becomes.

Adjusting Sharpness

Highlight **Sharpness** in the **Picture** menu and adjust the values by pressing ◀/▶ on the projector or remote control.

The higher the value, the sharper the picture becomes. The lower the value, the softer the picture becomes.

Selecting a Color Temperature

Highlight **Color Temperature** in the **Picture** menu and adjust the values by pressing ◀/▶ on the projector or remote control.

The options available for color temperature* settings vary according to the signal type selected.

1. **Normal:** Maintains normal colorings for white.
2. **Cool:** Makes images appear bluish white.
3. **Lamp Native:** With the lamp's original color temperature and higher brightness. This setting is suitable for environment where high brightness is required, such as projecting pictures in well lit room.
4. **Warm:** Makes images appear reddish white.

*About color temperatures:

There are many different shades that are considered to be "white" for various purposes. One of the common methods of representing white color is known as the "color temperature". A white color with a low color temperature appears to be reddish white. A white color with a high color temperature appears to have more blue in it.

Advanced picture quality controls

There are more advanced functions in the **Picture > Advanced...** and **Display** menus to be adjusted to your preference. To save the settings, just press **MENU/EXIT** to leave the OSD menu.

Setting Black Level

Highlight **Black Level** in the **Picture > Advanced...** menu and press ◀/▶ on the projector or remote control to select **0 IRE** or **7.5 IRE**.

The grayscale video signal is measured in IRE units. In some areas which use NTSC TV standard, the grayscale is measured from 7.5 IRE (black) to 100 IRE (white); however, in other areas where PAL equipment or Japanese NTSC standards are used, the grayscale is measured from 0 IRE (black) to 100 IRE (white). We suggest that you check the input source to see if it is with 0 IRE or 7.5 IRE, then select accordingly.

Controlling image clarity

You may have static or noisy projected pictures.

To achieve better picture clarity:

1. Highlight **Clarity Control** in the **Picture > Advanced...** menu and press **MODE/ENTER** on the projector or remote control to display the **Clarity Control** page.
2. Press ▼ to select **Noise Reduction** and press ◀/▶ to set the desired value.
 - **Noise Reduction:** Reduces electrical image noise caused by different media players. The higher the setting, the less the noise.

Setting a preferred color temperature

To set a preferred color temperature:

1. Highlight **Color Temperature Fine Tuning** in the **Picture > Advanced...** menu and press **MODE/ENTER**. The **Color Temperature Fine Tuning** page displays.
2. Press **▲/▼** to highlight the item you want to change and adjust the values by pressing **◀/▶**.
 - **Red Gain/Green Gain/Blue Gain:** Adjusts the contrast levels of Red, Green, and Blue.
 - **Red Offset/Green Offset/Blue Offset:** Adjusts the brightness levels of Red, Green, and Blue.
3. To save and leave the settings, press **MENU/EXIT**.

Selecting a Gamma setting

Highlight **Gamma Selection** in the **Picture > Advanced...** menu and select a preferred setting by pressing **◀/▶** on the projector or remote control.

Gamma refers to the relationship between input source and picture brightness.

- **Gamma 1.6/1.8/2.0/BenQ**
Select these values according to your preference.
- **Gamma 2.2**
Increases the average brightness of the picture. Best for a lit environment, meeting room or family room.
- **Gamma 2.4/2.5**
Best for viewing movies in a darkened environment.
- **Gamma 2.6/2.8**
Best for viewing movies which are mostly composed of dark scenes.

High Brightness
Low Contrast

Low Brightness
High Contrast

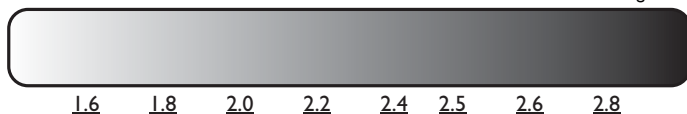

Brilliant Color

Highlight **Brilliant Color** in the **Picture > Advanced...** menu and select by pressing **◀/▶** on the projector or remote control.

This feature utilizes a new color-processing algorithm and system level enhancements to enable higher brightness while providing truer, more vibrant colors in picture. It enables a greater than 50% brightness increase in mid-tone images, which are common in video and natural scenes, so the projector reproduces images in realistic and true colors. If you prefer images with that quality, select **On**. If you don't need it, select **Off**.

Color Management

In most installation situations, color management will not be necessary, such as in classroom, meeting room, or lounge room situations where lights remain on, or where building external windows allow daylight into the room.

Only in permanent installations with controlled lighting levels such as boardrooms, lecture theaters, or home theaters, should color management be considered. Color management provides fine color control adjustment to allow for more accurate color reproduction, should you require it.

Proper color management can only be achieved under controlled and reproducible viewing conditions. You will need to use a colorimeter (color light meter), and provide a set of suitable source images to measure color reproduction. These tools are not provided with the projector, however, your projector supplier should be able to provide you with suitable guidance, or even an experienced professional installer.

The Color Management provides six sets (RGBCMY) of colors to be adjusted. When you select each color, you can independently adjust its range and saturation according to your preference.

If you have purchased a test disc which contains various color test patterns and can be used to test the color presentation on monitors, TVs, projectors, etc. You can project any image from the disc on the screen and enter the **Color Management** menu to make adjustments.

To adjust the settings:

1. Go to the **Picture > Advanced...** menu and highlight **Color Management**.
2. Press **MODE/ENTER** and the **Color Management** page displays.
3. Highlight **Primary color** and press **◀/▶** to select a color from among Red, Green, Blue, Cyan, Magenta and Yellow.
4. Press **▼** to highlight **Hue** and press **◀/▶** to select its range. Increase in the range will include colors consisted of more proportions of its two adjacent colors.

Please refer to the illustration to the right for how the colors relate to each other.

For example, if you select Red and set its range at 0, only pure red in the projected picture will be selected. Increasing its range will include red close to yellow and red close to magenta.

5. Press **▼** to highlight **Saturation** and adjust its values to your preference by pressing **◀/▶**. Every adjustment made will reflect to the image immediately.

For example, if you select Red and set its value at 0, only the saturation of pure red will be affected.

6. Press **▼** to highlight **Gain** and adjust its values to your preference by pressing **◀/▶**. The contrast level of the primary color you select will be affected. Every adjustment made will reflect to the image immediately.
7. Repeat steps 3 to 6 for other color adjustments.
8. Make sure you have made all of the desired adjustments.
9. Press **MENU/EXIT** to exit and save the settings.

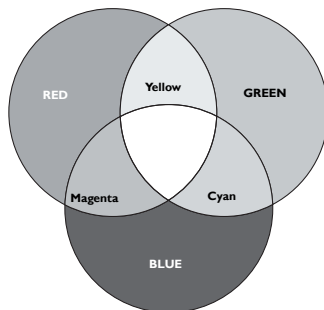

 Saturation is the amount of that color in a video picture. Lower settings produce less saturated colors; a setting of “0” removes that color from the image entirely. If the saturation is too high, that color will be overpowering and unrealistic.

Setting Film Mode

Highlight **Film Mode** in the **Display** menu and select **On** by pressing ◀ / ▶ on the projector or remote control.

This feature helps improve picture quality when projecting composite or S-video image from a filmsourced DVD or Blu-ray Disc.

Setting 3D Comb Filter

Highlight **3D Comb Filter** in the **Display** menu and select **On** by pressing ◀ / ▶ on the projector or remote control.

This feature separates composite signal to Y (brightness) signal and C (color) signal, and can help produce clearer and sharper images with correct colors in place.

 This function is only available when a composite or S-video signal is selected.

Adjusting the sound

The sound adjustments made as below will have an effect on the projector speakers. Be sure you have made a correct connection to the projector audio input. See ["Connection" on page 22](#) for how the audio input is connected.

Muting the sound

To temporarily turn off the sound,

- Using the remote control

Press **MUTE** to temporarily turn off the sound. While the sound is off, the screen will display  in the upper right corner of the screen.

To restore the sound, press **MUTE** again.

- Using the OSD menu

1. Press **MENU/EXIT** and then press ◀ / ▶ until the **System Setup: Advanced** menu is highlighted.
2. Press ▼ to highlight **Audio Settings** and press **ENTER**. The **Audio Settings** page displays.
3. Highlight **Mute** and press ◀ / ▶ to select **On**.
4. To restore the sound, repeat steps 1-3 and press ◀ / ▶ to select **Off**.

Adjusting the sound level

To adjust the sound level,

- Using the remote control

Press  or  to select a desired sound level.

- Using the OSD menu

1. Repeat steps 1-2 above.
2. Press ▼ to highlight **Volume** and press ◀ / ▶ to select a desired sound level.

Turning off the Power on/off ring tone

1. Repeat steps 1-2 above.
2. Press ▼ to highlight **Power on/off ring tone** and press ◀/▶ to select **Off**.

The only way to change Power on/off ring tone is setting **On** or **Off** here. Setting the sound mute or changing the sound level will not affect the Power on/off ring tone.

Selecting the aspect ratio

The 'aspect ratio' is the ratio of the image width to the image height. Most analog TV and computers are in 4:3 ratio, and digital TV and DVDs are usually in 16:9 ratio.

With the advent of digital signal processing, digital display devices like this projector can dynamically stretch and scale the image output to a different aspect than that of the image input signal.

To change the projected image ratio (no matter what aspect the source is):

1. Press **MENU/EXIT** and then press ◀/▶ until the **Display** menu is highlighted.
2. Press ▼ to highlight **Aspect Ratio**.
3. Press ◀/▶ to select an aspect ratio to suit the format of the video signal and your display requirements.

About the aspect ratio

 In the pictures below, the black portions are inactive areas and the white portions are active areas. OSD menus can be displayed on those unused black areas.

1. **Auto:** Scales an image proportionally to fit the projector's native resolution in its horizontal width. This is suitable for the incoming image which is neither in 4:3 nor 16:9 and you want to make most use of the screen without altering the image's aspect ratio.

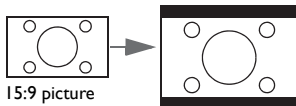

4. **16:9:** Scales an image so that it is displayed in the center of the screen with a 16:9 aspect ratio. This is most suitable for images which are already in a 16:9 aspect, like high definition TV, as it displays them without aspect alteration.

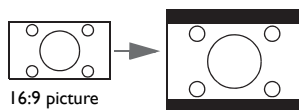

2. **Real:** The image is projected as its original resolution, and resized to fit within the display area. For input signals with lower resolutions, the projected image will display smaller than if resized to full screen. You could adjust the zoom setting or move the projector away from the screen to increase the image size if necessary. You may also need to refocus the projector after making these adjustments.

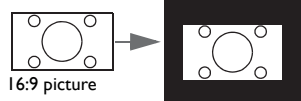
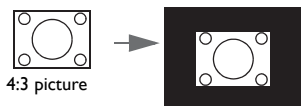

3. **4:3:** Scales an image so that it is displayed in the center of the screen with a 4:3 aspect ratio. This is most suitable for 4:3 images like computer monitors, standard definition TV and 4:3 images aspect DVD movies, as it displays them without aspect alteration.

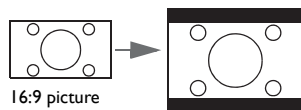

5. **Wide:** Stretches the picture horizontally in a non-linear manner; that is, the edges of the picture are stretched more than the center of the picture to prevent distortion of the central part of the picture. This is suitable for occasions where you want to stretch the width of a 4:3 aspect picture to the width of a 16:9 aspect screen. It does not alter the height. Some widescreen movies have been produced with their width squashed down to the width of a 4:3 aspect, and are best viewed when restretched back to their original width using this setting..

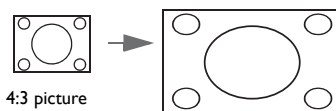

6. **Letter Box:** Scales a picture to fit the projector's native resolution in its horizontal width and resize the picture's height to the 3/4 of the projection width. This may produce a picture greater in height than can be displayed, so part of the picture is lost (not displayed) along the top and bottom edges of the projection. This is suitable for the display of movies which are presented in letter box format (with black bars on the top and bottom).

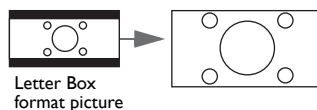
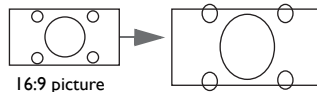

- The black portions are inactive areas and the white portions are active areas.
- OSD menus can be displayed on those unused black areas.

Magnifying and searching for details

If you need to find the details on the projected picture, magnify the picture. Use the direction arrow keys for navigating the picture.

1. Press **MENU/EXIT** and then press ◀/▶ until the **Display** menu is highlighted.
2. Press ▼ to highlight **Digital Zoom** and press **MODE/ENTER**. The Zoom bar displays.
3. Press ▲ on the projector repeatedly to magnify the picture to a desired size.
4. To navigate the picture, press **MODE/ENTER** to switch to the panning mode and press the directional arrows (▲, ▼, ◀, ▶) to navigate the picture.
5. To reduce size of the picture, press **MODE/ENTER** to switch back to the zoom in/out functionality, and press **AUTO** to restore the picture to its original size. You can also press ▼ repeatedly until it is restored to the original size.

 The picture can only be navigated after the picture is magnified. You can further magnify the picture while searching for details.

Playing 3D function

1. To enter the special preset mode, press **MENU/EXIT** and then press ◀/▶ until the **Display** menu is highlighted, and press ◀/▶ to enable or disable **3D**. When the **3D Auto** is enabled, the current picture mode adjustment will be disabled.
2. To invert the image, press **MENU/EXIT** and then press ◀/▶ until the **Display** menu is highlighted, and press ◀/▶ to enable or disable **3D Sync Invert**.
3. **3D Requirement:**
 - PC: PC with graphic card with stereo capability (Quad buffer feature) and can run at 120Hz/60Hz refresh rate.
 - Video: standard NTSC/PAL DVD player to output 60Hz/50Hz movie.
 - 55% of the brightness will loss.

 To enjoy the 3D function, first enable the Play Movie in 3D setting found in your DVD devices under the 3D Disc Menu.

Personalizing the projector menu display

The On-Screen Display (OSD) menus can be set according to your preferences. The following settings do not affect the projection settings, operation, or performance.

- **Menu display time** in the **System Setup: Basic > Menu Settings** menu sets the length of time the OSD will remain active after your last key press. The time length ranges from 5 to 30 seconds in 5-second increments. Use ◀/▶ to select a suitable time frame.
- **Menu position** in the **System Setup: Basic > Menu Settings** menu sets the OSD position in five locations. Use ◀/▶ to select a preferred position.
- **Language** in the **System Setup: Basic** menu sets your familiar language for the OSD menus. Use ◀/▶ to select your language.
- **Splash Screen** in the **System Setup: Basic** menu sets a preferred logo screen to be displayed during projector start-up. Use ◀/▶ to select a screen.

Operating in a high altitude environment

We recommend you use the **High Altitude Mode** when your environment is between 1500 m –3000 m above sea level, and temperature is between 0°C–30°C.



Do not use the High Altitude Mode if your altitude is between 0 m and 1500 m and temperature is between 0°C and 35°C. The projector will be over cooled, if you turn the mode on under such a condition.

To activate the **High Altitude Mode**:

1. Press **MENU/EXIT** and then press **◀/▶** until the **System Setup: Advanced** menu is highlighted.
2. Press **▼** to highlight **High Altitude Mode** and press **◀/▶** to select **On**. A confirmation message displays.
3. Highlight **Yes** and press **MODE/ENTER**.

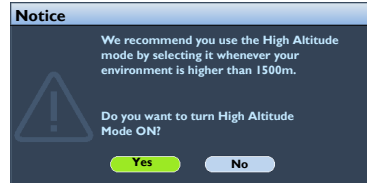

Operation under "**High Altitude Mode**" may cause a higher decibel operating noise level because of increased fan speed necessary to improve overall system cooling and performance.

If you use this projector under other extreme conditions excluding the above, it may display auto shut-down symptoms, which is designed to protect your projector from over-heating. In cases like this, you should switch to High Altitude mode to solve these symptoms. However, this is not to state that this projector can operate under any and all harsh or extreme conditions.

Locking control keys

With the control keys on the remote control and projector locked, you can prevent your projector settings from being changed accidentally (by children, for example). When Key Lock is on, no control keys on the remote control and projector will operate except **POWER** and **▶**.

To lock the keys:

1. Press **MENU/EXIT** and then press **◀/▶** until the **System Setup: Advanced** menu is highlighted.
2. Press **▼** to highlight **Key Lock**, and press **◀/▶** to select **On**. A warning message appears. Select **Yes** and press **MODE/ENTER**. The control keys lock.

To unlock the keys, press **▶** and hold on the projector or remote control for 3 seconds.

Hiding the image

In order to draw the audience's full attention to the presenter, you can use **ECO BLANK** on the projector or remote control to hide the screen image. Press any key on the projector or remote control to restore the image. The word '**BLANK**' appears at the lower right corner of the screen while the image is hidden.



- Do not block the projection lens from projecting as this could cause the blocking object to become heated and deformed or even cause a fire.

Freezing the image

Press **FREEZE** on the remote control to freeze the image. The word '**FREEZE**' will display in the upper left corner of the screen. To release the function, press any key on the projector or remote control.

Even if an image is frozen on the screen, the pictures are running on the video or other device. If the connected devices have active audio output, you will still hear the audio even though the image is frozen on screen.

Shutting down the projector

1. To turn the projector off, press **POWER OFF** on the remote control to turn projector off directly. Or you can press  **POWER** on the projector and a warning message appears.

Press  **POWER** again.

2. Once the cooling process finishes, the **POWER indicator light** is a steady orange and fans stop.
3. Disconnect the power cord from the wall socket if the projector will not be used in an extended period of time.

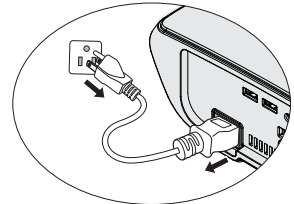

- To protect the lamp, the projector will not respond to any commands during the cooling process.
- To shorten the cooling time, you can also activate the **Quick Cooling** function. See "[Quick Cooling](#)" on page 56 for details.
- If the projector is not properly shut down, to protect the lamp, when you attempt to re-start the projector, the fans will run for a few minutes to cool down. Press **POWER** again to start the projector after the fans stop and the **POWER** indicator light turns orange.
- Lamp life results will vary depending on environmental conditions, and usage.

Menu operation

Menu system

Please note that the on-screen display (OSD) menus vary according to the signal type selected.

Main menu	Sub-menu	Options
	Preset Mode	ISF Disabled: Dynamic/ Standard /Cinema/User 1/User 2 ISF Enabled: Dynamic/Standard/Cinema/User 1/User 2/ ISF Night /ISF Day 3D Enabled: 3D /User3
	User Mode Management	ISF Disabled: Dynamic/Standard/Cinema/User 1/User 2 ISF Enabled: Dynamic/Standard/Cinema/User 1/User 2/ISF Night /ISF Day 3D Enabled: 3D /User3
	Rename User Mode	Keyboard popup
	Brightness	
	Contrast	
	Color	
	Tint	
	Sharpness	
	Color Temperature	Normal /Cool/Lamp Native/Warm
	Lamp Power	Normal Normal/Economic/SmartEco
	Black Level	
	Clarity Control	Noise Reduction:0-31
	Color Temperature Fine Tuning	Red Gain/Green Gain/Blue Gain/ Red Offset/Green Offset/Blue Offset
	Advanced...	1.6/1.8/2.0/2.2/2.4/2.5/2.6/2.8/ BenQ
	Gamma Selection	On/Off
	Brilliant Color	Primary Color (Red/Green/Blue/Cyan/Magenta/ Yellow)/Hue/Gain/Saturation
	Reset Picture Settings	Reset/ Cancel
	Mute	
	Volume	
2. Audio Setup	Power On/Off	
	Ring Tone	

1. Picture

2.



Audio Setup

Main menu	Sub-menu	Options	
3. Display	Aspect Ratio	Auto/Real/16:9/4:3/Wide/ Letter Box	
	Keystone		
	Position		
	Overscan Adjustment		
	PC & Component YPbPr Tuning	H. Size/Phase/Auto (Only for RGBHD PC Timing)	
	Digital Zoom		
	Film Mode	On/Off	
	3D Comb Filter	On/Off	
	3D	3D Mode	Auto (as signal has inframe)/Off/ Frame Sequential/Frame Packing/ Top-Bottom/Side-by-Side
		3D Sync Invert	
	4. System Setup: Basic	Language	ENGLISH/ FRANÇAIS/ DEUTSCH/ ITALIANO/ ESPAÑOL/ РУССКИЙ/ 繁體中文/ 简体中文/ 日本語/ 한국어/ Svenska/ Nederlands/ Türkçe/ Čeština/ Português/ বাংলা/ Polski/ Magyar/ Hrvatski/ Română/ Norsk/ Dansk/ български/ Suomi/ Ελληνικά/ Bahasa Indonesia
		Background Color	Black/Blue/Purple
		Splash Screen	BenQ/Black/Blue
Projector Position		Front Table/Rear Table/?Rear Ceiling/Front Ceiling	
Auto Off		Disable/5 min/10 min/15 min/ 20 min/25 min/30 min	
Sleep Timer		Disable/30 min/1 hr/2 hr/3 hr/ 4 hr/8 hr/12 hr	
Menu Settings		Menu Display Time	Always On/5 sec/10 sec/15 sec/ 20 sec/25 sec/30 sec
		Menu Position	Center/Top-Left/Top-Right/ Bottom-Right/Bottom-Left
		Blank Reminder Message	On/Off
Input Source			
Source Rename		Keyboard popup	
Auto Source Search			

Main menu	Sub-menu	Options	
5. System Setup: Advanced	Lamp Settings	Reset Lamp Timer	
		Equivalent Lamp Hour	
	HDMI Settings	HDMI Format	Auto/PC Signal/Video Signal PC Signal 0~255 level Video Signal 16~235 level
	Baud Rate		2400/4800/9600/14400/19200/ 38400/57600/115200
	Test Pattern		On/Off
	Closed Caption	Closed Caption Enable	On/Off
		Caption Version	CC1/CC2/CC3/CC4
	Quick Cooling		On/Off
	High Altitude Mode		On/Off
	Password	Change Password	
		Power On Lock	On/Off
	Key Lock		On/Off
	Reset All Settings		
		ISF	Input password
	6. Information	Current System Status	<ul style="list-style-type: none"> • Source • Preset Mode • Resolution • Color System • Equivalent Lamp Hour • 3D Format • Firmware Version

Note that the menu items are available when the projector detects at least one valid signal. If there is no equipment connected to the projector or no signal detected, limited menu items are accessible.

Description of each menu

		FUNCTION	DESCRIPTION
1. Picture menu	Preset Mode		Pre-defined picture modes are provided so you can optimize your projector image set-up to suit your program type. See " Fine-tuning the selected picture mode " on page 36 for details.
	User Mode Management		Selects a preset mode that most suits your need for the picture quality and further fine tune the picture based on the selects list below. See " Setting the User 1/User 2/User 3 mode " on page 37 for detail.
	Brightness		Adjusts the brightness of the image. See " Adjusting Brightness " on page 38 for details.
	Contrast		Adjusts the degree of difference between dark and light in the image. See " Adjusting Contrast " on page 38 for details.
	Color		Adjusts the color saturation level -- the amount of each color in a video image. See " Adjusting Color " on page 38 for details. The function is only available when Video or S-Video with NTSC system is selected.
	Tint		Adjusts the red and green color tones of the image. See " Adjusting Tint " on page 38 for details. The function is only available when Video or S-Video with NTSC system is selected.
	Sharpness		Adjusts the image to make it look sharper or softer. See " Adjusting Sharpness " on page 38 for details. The function is only available when Video or S-Video with NTSC system is selected.
	Color Temperature		See " Selecting a Color Temperature " on page 39 for details.
	Lamp Power		Selects the projector lamp power between Normal , Economic and SmartEco modes.



FUNCTION	DESCRIPTION	
1. Picture menu Advanced...	<p>Black Level Sets the picture grayscale as 0 IRE or 7.5 IRE. See "Setting Black Level" on page 39 for details.</p> <p>Clarity Control See "Controlling image clarity" on page 39 for details.</p> <p>Color Temperature Fine Tuning See "Setting a preferred color temperature" on page 40 for details.</p> <p>Gamma Selection See "Selecting a Gamma setting" on page 40 for details.</p> <p>Brilliant Color Adjusts white peaking while maintaining correct color presentation. See "Brilliant Color" on page 40 for details.</p> <p>Color Management See "Color Management" on page 41 for details.</p>	
	<p>Reset Picture Settings Returns all settings in the Picture menu to the factory preset values. See "Resetting the picture mode" on page 37 for details.</p>	
	2. Audio Setup menu Mute	<p>See "Muting the sound" on page 42 for details.</p>
	Volume	<p>See "Adjusting the sound level" on page 42 for details.</p>
	Power On/Off ring tone	<p>See "Turning off the Power on/off ring tone" on page 43 for details.</p>

FUNCTION		DESCRIPTION	
3. Display menu	Aspect Ratio	There are several options to set the image's aspect ratio depending on your input signal source. See "Selecting the aspect ratio" on page 43 for details.	
	Keystone	Corrects any keystone of the image manually. See "Correcting keystone" on page 30 for details.	
	Position	Displays the position adjustment page. To move the projected image, use the directional arrow keys. The values shown on the lower position of the page change with every key press you made until they reach their maximum or minimum. This function is only available when a PC signal (analog RGB) is selected.	
	Overscan Adjustment	Conceals the poor picture quality in the four edges. You can also manually press ◀/▶ to decide how much to be concealed. Setting 0 means the picture is 100% displayed. The greater the value, the more portion of the picture is concealed while the screen remains filled and geometrically accurate.	
	PC & Component YPbPr Tuning	H. Size	Adjusts the horizontal width of the picture. ☞ This function is only available when the PC signal (analog RGB) is selected.
		Phase	Adjusts the clock phase to reduce picture distortion. ☞ This function is only available when the PC signal (analog RGB) is selected.
		Auto (Only for RGBHD PC Timing)	Adjusts the phase, and frequency automatically. ☞ This function is only available when the PC signal is selected.
Digital Zoom	Magnifies or reduces the projected image. See "Magnifying and searching for details" on page 45 for details.		



	FUNCTION	DESCRIPTION
3. Display menu	Film Mode	See "Setting Film Mode" on page 42 for details.
	3D Comb Filter	See "Setting 3D Comb Filter" on page 42 for details.
	3D	<p>3D Mode</p> <p>This projector features a 3D function which enables you to enjoy the 3D movies, videos, and sporting events in a more realistic way by pressing the depth of the images. You need to wear a pair of 3D glasses to view the 3D images.</p> <p> When the 3D mode function is enabled:</p> <ul style="list-style-type: none"> • The brightness level of the projected image will decrease. • The Preset Mode cannot be adjusted. • The Keystone can only be adjusted within limited degrees. <p>3D Sync Invert</p> <p>When your 3D image is distorted, you can enable this function to switch between the image for the left eye and the right eye for the more comfortable 3D viewing experience.</p>
4. System Setup: Basic menu	Language	Sets the language for the On-Screen Display (OSD) menus. See "Using the menus" on page 31 for details.
	Background Color	Sets the background color for the projector. See "Personalizing the projector menu display" on page 45 for details.
	Splash Screen	Allows you to select which logo screen will display during projector start-up. Three options are available: BenQ logo, Black screen, or Blue screen.
	Projector Position	The projector can be installed on a ceiling or behind a screen, or with one or more mirrors. See "Choosing a location" on page 16 for details.
	Auto Off	Allows the projector to turn off automatically if no input signal is detected after a set period of time. See "Setting Auto Off" on page 59 for details.
	Sleep Timer	Sets the auto-shutdown timer. The timer can be set to a value between 30 minutes and 12 hours.

FUNCTION	DESCRIPTION
4. System Setup: Basic menu	<p>Menu Display Time Sets the length of time the OSD will remain active after your last key press. The range is from 5 to 30 seconds in 5-second increments.</p> <p>Menu Position Sets the On-Screen Display (OSD) menu position.</p> <p>Blank Reminder Message Selecting On allows the projector to show you to blank reminder message.</p>
	<p>Input Source Select an input source to be projected. See "Switching input signal" on page 35 for details.</p>
	<p>Source Rename Rename the source to your desired name. See "Switching input signal" on page 35 for details.</p>
	<p>Auto Source Search Set whether the projector searches automatically for input sources. If the sources scan is On, the projector will scan for input sources until it acquires a signal. If the function is not activated, the projector selects the last used input source.</p>
	5. System Setup: Advanced menu
<p>HDMI Settings</p> <p>HDMI Format Selects an input source type for the HDMI signal. You can also manually select the source type. The different source types carry different standards for the brightness level.</p> <p> HDMI Format is only available when the HDMI signal is selected.</p> <p>CEC Enables or disables the CEC function. When you connect an HDMI CEC compatible device to your projector with an HDMI cable, turn on the HDMI CEC compatible device automatically turns on the projector, while turn off the projector automatically turns off the HDMI CEC compatible device.</p>	
<p>Baud Rate Selects a baud rate that is identical with your computer's so that you can connect the projector using a suitable RS-232 cable and update or download the projector's firmware. This function is intended for qualified service personnel.</p>	
<p>Test Pattern Selecting On enables the function and the projector displays the grid test pattern. It helps you adjust the image size and focus and check that the projected image is free from distortion.</p>	

FUNCTION	DESCRIPTION
Closed Caption	<p>Closed Caption Enable Selecting On enables the function. The closed captioning text is displayed if available.</p> <p> Close Caption will disable when aspect change to 16:9, 16:10 or real.</p> <p>Caption Version Selects a preferred closed captioning mode. To view captions, select CC1, CC2, CC3, or CC4 (CC1 displays captions in the primary language in your area).</p>
	<p>Quick Cooling Enables or disables the Quick Cooling function. Selecting On enables the function and projector cooling time will be shortened from a normal 90-second duration to approximately 30 seconds.</p>
High Altitude Mode	<p>A mode for operation in high altitude areas. See "Operating in a high altitude environment" on page 46 for details.</p>
Password	<p>Change Password You will be asked to enter the current password before changing to a new one. See "Utilizing the password function" on page 32 for details.</p>
	<p>Power On Lock Limits use of the projector to only those who know the correct password. See "Utilizing the password function" on page 32 for details.</p>
Key Lock	<p>See "Locking control keys" on page 46 for details.</p>
Reset All Settings	<p>Returns all settings to the factory preset values.</p> <p> The following settings will still remain: Keystone, Language, Projector Position, High Altitude Mode, Password, Key Lock, and ISF.</p>
ISF	<p>The ISF calibration menu is password protected and only accessible by authorized ISF calibrators. The ISF (Imaging Science Foundation) has developed carefully crafted, industry-recognized standards for optimal video performance and has implemented a training program for technicians and installers to use these standards to obtain optimal picture quality from BenQ video display devices. Accordingly, we recommend that setup and calibration be performed by an ISF certified installation technician.</p> <p> For more information, please go to www.imagingscience.com or contact the place you purchased the projector.</p>

FUNCTION	DESCRIPTION
<p style="writing-mode: vertical-rl; transform: rotate(180deg);">6. Information menu</p> <p>Current System Status</p>	<p>Source Shows the current signal source.</p> <p>Preset Mode Shows the selected mode in the Preset menu.</p> <p>Resolution Shows the native resolution of the input signal.</p> <p>Color System Shows input system format, NTSC, PAL, SECAM or RGB.</p> <p>Equivalent Lamp Hour Displays the number of hours the lamp has been used.</p> <p>3D Format Shows the current 3D mode.</p> <p> 3D Format is only available when 3D Mode is enabled.</p> <p>Firmware Version Displays the firmware version of the projector.</p>

 The Information menu shows you the current operating status of the projector.

Maintenance

Care of the projector

Your projector needs little maintenance. The only thing you need to do on a regular basis is to keep the lens clean.

Never remove any parts of the projector except the lamp. Contact your dealer if other parts need replacing.

Cleaning the lens

Clean the lens whenever you notice dirt or dust on the surface.

- Use a canister of compressed air to remove dust.
- If there is dirt or smears, use lens-cleaning paper or moisten a soft cloth with lens cleaner and gently wipe the lens surface.



Never use any type of abrasive pad, alkaline/acid cleaner, scouring powder, or volatile solvent, such as alcohol, benzene, thinner or insecticide. Using such materials or maintaining prolonged contact with rubber or vinyl materials may result in damage to the projector surface and cabinet material.

Cleaning the projector case

Before you clean the case, turn the projector off using the proper shutdown procedure as described in "[Shutting down the projector](#)" on [page 47](#) and unplug the power cord.

- To remove dirt or dust, wipe the case with a soft, lint-free cloth.
- To remove stubborn dirt or stains, moisten a soft cloth with water and a neutral pH detergent. Then wipe the case.



Never use wax, alcohol, benzene, thinner or other chemical detergents. These can damage the case.

Storing the projector

If you need to store the projector for an extended time, please follow the instructions below:

- Make sure the temperature and humidity of the storage area are within the recommended range for the projector. Please refer to "[Specifications](#)" on [page 66](#) or consult your dealer about the range.
- Retract the adjuster feet.
- Remove the battery from the remote control.
- Pack the projector in its original packing or equivalent.

Transporting the projector

It is recommended that you ship the projector with its original packing or equivalent. When you carry the projector yourself, please use the original box or a suitable soft carry case.

Lamp information

Getting to know the lamp hour

When the projector is in operation, the duration (in hours) of lamp usage is automatically calculated by the built-in timer. The method of calculating the equivalent lamp hour is as follows:

 See "**Setting Lamp mode as Economic or SmartEco**" below for more information on **Economic mode**.

To obtain the lamp hour information:

1. Press **MENU/EXIT** and then press **◀/▶** until the **System Setup: Advanced** menu is highlighted.
2. Press **▼** to highlight **Lamp Settings** and press **MODE/ENTER**. The **Lamp Settings** page displays.
3. You will see the **Equivalent lamp hour** information displaying on the menu.
4. To leave the menu, press **MENU/EXIT**.

You can also get the lamp hour information on the **Information** menu.

Extending lamp life

The projection lamp is a consumable item. To keep the lamp life as long as possible, you can do the following settings via the OSD menu.

Setting Lamp mode as Economic or SmartEco

Using **Economic** mode reduces system noise and power consumption by 30%. Using **SmartEco** mode reduces system noise and lamp power consumption by up to 70%. If the **Economic** or **SmartEco** mode is selected, the light output will be reduced and result in darker projected pictures

Setting the projector in **Economic** or **SmartEco** mode also extends the lamp life. To set **Economic** or **SmartEco** mode, go to the **Picture > Lamp Settings > Lamp Power** menu, and press **MODE/ENTER**. The **Lamp Power** page displays. Then press **▲/▼** repeatedly until your desired mode is selected and press **MODE/ENTER**.

Lamp mode	Description
Normal	100% lamp brightness
Economic	Saves 30% lamp power consumption
SmartEco	Saves up to 70% lamp power consumption depending on the content brightness level

Setting Auto Off

This function allows the projector to turn off automatically if no input source is detected after a set period of time to prevent unnecessary waste of lamp life.

To set **Auto Off**, go into the **System Setup: Basic > Auto Off** menu and press **◀/▶**. The time period can be set from 5 to 30 minutes in 5-minute increments. If the preset time lengths are not suitable for your presentation, select **Disable**. The projector will not automatically shut down in a certain time period.

Timing of replacing the lamp



When the **Lamp indicator** lights up red or a message appears suggesting it is time to replace the lamp, please install a new lamp or consult your dealer. An old lamp may cause a malfunction in the projector and in some instances the lamp may explode.

Go to <http://lamp.benq.com> for a replacement lamp.

 **The Lamp indicator light and Temperature warning light will light up if the lamp becomes too hot. See "Indicators" on page 64 for details.**

The following lamp warning displays will remind you to change the lamp.

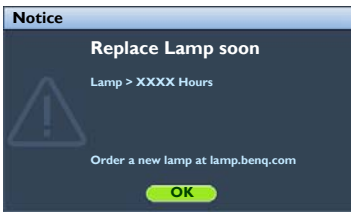
 **The warning messages below are for reference only. Please follow the actual on-screen instructions to prepare and replace the lamp.**

Status	Message
<p>Install a new lamp for optimal performance. If the projector is normally run with Economic selected (See "Setting Lamp mode as Economic or SmartEco" on page 59), you may continue to operate the projector until the next lamp warning appears.</p>	
<p>A new lamp should be fitted to avoid the inconvenience when the projector runs out of lamp time.</p>	
<p>It is strongly recommended that you replace the lamp at this age. The lamp is a consumable item. The lamp brightness diminishes with use. This is normal lamp behavior. You can replace the lamp whenever you notice that the brightness level has significantly diminished.</p>	
<p>The lamp MUST be replaced before the projector will operate normally.</p>	

Replacing the lamp



- If lamp replacement is performed while the projector is suspended upside-down from the ceiling, make sure that no one is underneath the lamp socket to avoid any possible injury or damage to the human eyes caused by fractured lamp.
- To reduce the risk of electrical shock, always turn the projector off and disconnect the power cord before changing the lamp.
- To reduce the risk of severe burns, allow the projector to cool for at least 45 minutes before replacing the lamp.
- To reduce the risk of injuries to fingers and damage to internal components, use caution when removing lamp glass that has shattered into sharp pieces.
- To reduce the risk of injuries to fingers and/or compromising image quality by touching the lens, do not touch the empty lamp compartment when the lamp is removed.
- This lamp contains mercury. Consult your local hazardous waste regulations to dispose of this lamp in a proper manner.
- To assure optimal performance from the projector, it is recommended that you purchase a BenQ projector lamp for lamp replacement.
- Ensure good ventilation when handling broken lamps. We recommend that you use respirators, safety glasses, goggles or face shield and wear protective clothing such as gloves.

1. Turn the power off and disconnect the projector from the wall socket. If the lamp is hot, avoid burns by waiting for approximately 45 minutes until the lamp has cooled.
2. Loosen the captive screw from the front.
3. Remove the lamp compartment cover as shown.

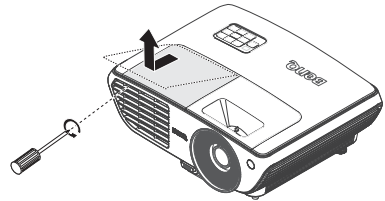

4. Loosen the three captive screws that secure the lamp.



- Do not turn the power on with the lamp cover removed.
- Do not insert your fingers between the lamp and the projector. The sharp edges inside the projector may cause injuries.

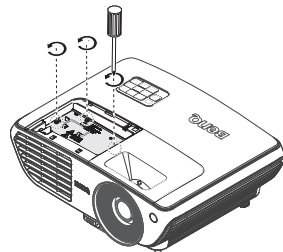

- Lift the handle so that it stands up. Use the handle to slowly pull the lamp out of the projector.



- **Pulling it too quickly may cause the lamp to break and scatter broken glass in the projector.**
- **Do not place the lamp in locations where water might splash on it, children can reach it, or near flammable materials.**
- **Do not insert your hands into the projector after the lamp is removed. If you touch the optical components inside, it could cause color unevenness and distortion of the projected images.**

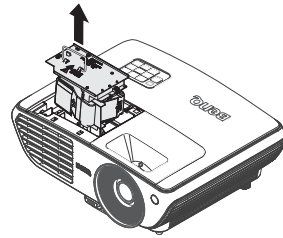

- Insert the new lamp into the lamp compartment and make sure it fits in the projector.



- **Ensure the connectors are aligned.**
- **If you experience resistance, lift the lamp and start again.**

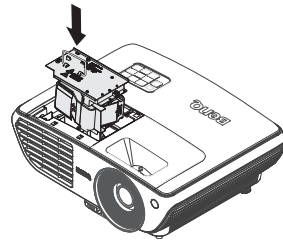

- Tighten the screws that secure the lamp.
- Ensure the handle is fully laid flat and locked in place.



- **Loose screw may cause a bad connection, which could result in malfunction.**
- **Do not over tighten the screw.**

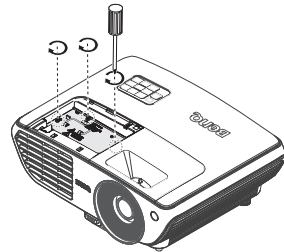

- Replace the lamp compartment cover on the projector and tighten the captive screw.

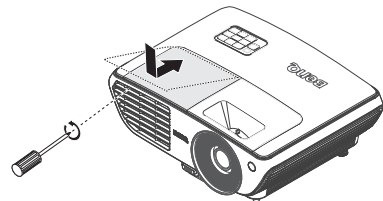

- Restart the projector.



- **Do not turn the power on with the lamp cover removed.**

Resetting the lamp timer

11. After the startup logo, open the On-Screen Display (OSD) menu. Go to the **System Setup: Advanced > Lamp Settings** menu. Press **MODE/ENTER**. The **Lamp Settings** page displays. Press **▼** to highlight **Reset lamp timer** and press **MODE/ENTER**. A warning message displays asking if you want to reset the lamp timer. Highlight **Reset** and press **MODE/ENTER**. The lamp time will be reset to '0'.



Do not reset if the lamp is not new or replaced as this could cause damage.

Indicators

Light			Status & Description	
Power	Temp	Lamp		
Power events				
Orange	Off	Off	Stand-by mode	
Green Flashing	Off	Off	Powering up	
Green	Off	Off	Normal operation	
Orange Flashing	Off	Off	Projector is cooling.	
Lamp events				
Off	Off	Orange Flashing	The lamp is not lit up.	
Off	Off	Red	<ol style="list-style-type: none"> 1. The projector needs 90 seconds to cool down. Or 2. Please contact your dealer for assistance. 	
Thermal events				
Red	Red	Red	The fans are not working.	The projector has shutdown automatically. If you try to re-start the projector, it will shutdown again. Please contact your dealer for assistance.
Red	Red	Off		
Red	Red	Orange		
Green	Orange	Off	The internal temperature is too high. <ul style="list-style-type: none"> • The intake ventilation or the exhaust ventilation is blocked. • The projector may be in a poorly ventilated location. • The ambient temperature may be too high. 	
Green	Orange	Red		
Green	Orange	Orange		
Green	Orange	Green		
Green	Red	Red		
System events				
Green	Off	Red	The projector has shutdown automatically. If you try to re-start the projector, it will shutdown again. Please contact your dealer for assistance.	
Red Flashing	Off	Off		
Red	Off	Red		
Off	Green	Red	Lamp door is open. Please check if the lamp door is open or not closed properly.	

Troubleshooting

? The projector does not turn on.

Cause	Remedy
There is no power from the power cable.	Plug the power cord into the AC inlet on the projector, and plug the power cord into the power outlet. If the power outlet has a switch, make sure that it is switched on.
Attempting to turn the projector on again during the cooling process.	Wait until the cooling down process has completed.

? No picture

Cause	Remedy
The video source is not turned on or connected correctly.	Turn the video source on and check that the signal cable is connected correctly.
The projector is not correctly connected to the input signal device.	Check the connection.
The input signal has not been correctly selected.	Select the correct input signal with the SOURCE key on the projector or remote control.

? Blurred image

Cause	Remedy
The projection lens is not correctly focused.	Adjust the focus of the lens using the focus ring.
The projector and the screen are not aligned properly.	Adjust the projection angle and direction as well as the height of the unit if necessary.

? Remote control does not work

Cause	Remedy
The battery is out of power.	Replace the battery with new one.
There is an obstacle between the remote control and the projector.	Remove the obstacle.
You are too far away from the projector.	Stand within 7 meters (23 feet) of the projector.

? The password is incorrect

Cause	Remedy
You do not remember the password.	Please see "Entering the password recall procedure" on page 33 for details.

Specifications

Projector specifications

 All specifications are subject to change without notice.

Optical

Resolution
1080p
Display system
Single-chip DLP™ system
Lens F/Number
F = 2.42 to 2.97, f = 20.7 to 31.88 mm
Lamp
240W lamp

Electrical

Power supply
AC100-240V, 3.5A
50-60 Hz (Automatic)
Power consumption
300W (Max); < 0.5W (Standby)

Mechanical

Weight
7.5 lbs (3.4 Kg)

Output terminals

Speaker
(Mono) 10 watt x 1
Audio signal output
PC audio jack x 1

Control

USB
Mini B Type
RS-232 serial control
9 pin x 1
IR receiver x 2
12V TRIGGER
12VDC (Max. 0.5 A) x 1

Input terminals

Computer input
RGB input
D-Sub 15-pin (female) x 1
Video signal input
VIDEO
RCA jack x 1
SD/HDTV signal input
Analog - Component RCA jack x 3
Digital - HDMI x 1
Audio signal input
Audio in
PC audio jack x 1
RCA audio jack (L/R) x 1

Environmental Requirements

Operating temperature
0°C–40°C at sea level
Operating relative humidity
10%–90% (without condensation)
Operating altitude
0–1499 m at 0°C–35°C
1500–3000 m at 0°C–30°C (with High Altitude Mode on)

Dimensions

330 mm (W) x 128 mm (H) x 257 mm (D)

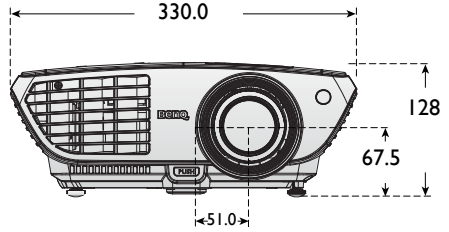
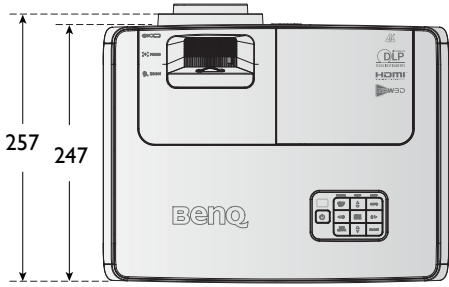

Ceiling Mount Installation

*Ceiling Mount Screws:
M4 (Max. L=25, Min. L=20)

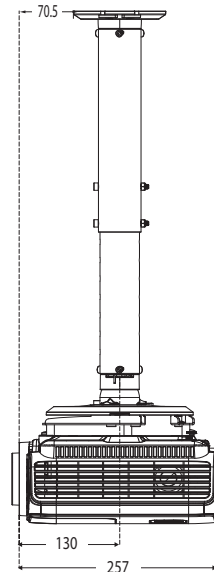
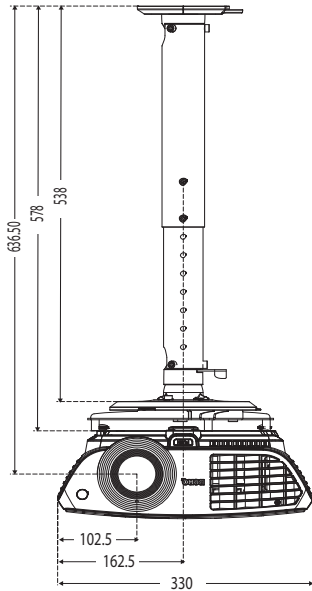
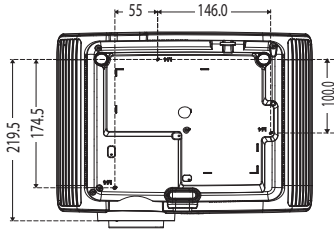

Unit: mm

Timing chart

Supported timing for PC input

Resolution	Format	Refresh rate (Hz)	H- frequency (kHz)	Pixel Frequency (MHz)
720 x 400	720 x 400_70	70.087	31.469	28.3221
640 x 480	VGA_60*	59.94	31.469	25.175
	VGA_72	72.809	37.861	31.5
	VGA_75	75	37.5	31.5
	VGA_85	85.008	43.269	36
800 x 600	SVGA_60*	60.317	37.879	40
	SVGA_72	72.188	48.077	50
	SVGA_75	75	46.875	49.5
	SVGA_85	85.061	53.674	56.25
	SVGA_120** (Reduce Blanking)	119.854	77.425	83
1024 x 768	XGA_60*	60.004	48.363	65
	XGA_70	70.069	56.476	75
	XGA_75	75.029	60.023	78.75
	XGA_85	84.997	68.667	94.5
	XGA_120** (Reduce Blanking)	119.989	97.551	115.5
1152 x 864	1152 x 864_75	75	67.5	108
1024 x 576	BenQ Notebook Timing	60	35.82	46.966
1024 x 600	BenQ Notebook Timing	64.995	41.467	51.419
1280 x 720	1280 x 720_60*	60	45	74.25
1280 x 768	1280 x 768_60*	59.87	47.776	79.5
1280 x 800	WXGA_60*	59.81	49.702	83.5
	WXGA_75	74.934	62.795	106.5
	WXGA_85	84.88	71.554	122.5
	WXGA_120** (Reduce Blanking)	119.909	101.563	146.25
1280 x 1024	SXGA_60***	60.02	63.981	108
	SXGA_75	75.025	79.976	135
	SXGA_85	85.024	91.146	157.5

Resolution	Format	Refresh rate (Hz)	H- frequency (kHz)	Pixel Frequency (MHz)
1280 x 960	1280 x 960_60***	60	60	108
	1280 x 960_85	85.002	85.938	148.5
1360 x 768	1360 x 768_60***	60.015	47.712	85.5
1440 x 900	WXGA+_60***	59.887	55.935	106.5
1400 x 1050	SXGA+_60***	59.978	65.317	121.75
1600 x 1200	UXGA***	60	75	162
1680 x 1050	1680 x 1050_60***	59.954	65.29	146.25
640 x 480@67Hz	MAC13	66.667	35	30.24
832 x 624@75Hz	MAC16	74.546	49.722	57.28
1024 x 768@75Hz	MAC19	74.93	60.241	80
1152 x 870@75Hz	MAC21	75.06	68.68	100

* Supported timing for 3D signal with Frame Sequential, Top-Bottom and Side-by-Side format.

** Supported timing for 3D signal with Frame Sequential format.

*** Supported timing for 3D signal with Top-Bottom and Side-by-Side format.

- The timings showing above may not be supported due to EDID file and VGA graphic card limitations. It is possible that some timings cannot be chosen.

Support timing for Component - YPbPr input

Format	Resolution	Refresh rate (Hz)	H- frequency (kHz)	Pixel Frequency (MHz)
480i*	720 x 480	59.94	15.73	13.5
480p*	720 x 480	59.94	31.47	27
576i	720 x 576	50	15.63	13.5
576p	720 x 576	50	31.25	27
720/50p	1280 x 720	50	37.5	74.25
720/60p*	1280 x 720	60	45	74.25
1080/50i	1920 x 1080	50	28.13	74.25
1080/60i	1920 x 1080	60	33.75	74.25
1080/24p	1920 x 1080	24	27	74.25
1080/25p	1920 x 1080	25	28.13	74.25
1080/30p	1920 x 1080	30	33.75	74.25
1080/50p	1920 x 1080	50	56.25	148.5
1080/60p	1920 x 1080	60	67.5	148.5

* Supported timing for 3D signal with Frame Sequential format.

Support timing for Video input

Format	Resolution	Refresh rate (Hz)	H- frequency (kHz)	Pixel Frequency (MHz)
NTSC*	-	60	15.73	3.58
PAL	-	50	15.63	4.43
SECAM	-	50	15.63	4.25 or 4.41
PAL-M	-	60	15.73	3.58
PAL-N	-	50	15.63	3.58
PAL-60	-	60	15.73	4.43
NTSC4.43	-	60	15.73	4.43

* Supported timing for 3D signal with Frame Sequential format.

Support timing for HDMI (HDCP) input

Resolution	Format	Refresh rate (Hz)	H- frequency (kHz)	Pixel Frequency (MHz)
640 x 480	VGA_60*	59.94	31.469	25.175
	VGA_72	72.809	37.861	31.5
	VGA_75	75	37.5	31.5
	VGA_85	85.008	43.269	36
720 x 400	720 x 400_70	70.087	31.469	28.3221
800 x 600	SVGA_60*	60.317	37.879	40
	SVGA_72	72.188	48.077	50
	SVGA_75	75	46.875	49.5
	SVGA_85	85.061	53.674	56.25
	SVGA_120** (Reduce Blanking)	119.854	77.425	83
1024 x 768	XGA_60*	60.004	48.363	65
	XGA_70	70.069	56.476	75
	XGA_75	75.029	60.023	78.75
	XGA_85	84.997	68.667	94.5
	XGA_120** (Reduce Blanking)	119.989	97.551	115.5
1152 x 864	1152 x 864_75	75	67.5	108
1024 x 576	BenQ Notebook Timing	60	35.82	46.996
1024 x 600	BenQ Notebook Timing	64.995	41.467	51.419
1280 x 720	1280 x 720_60*	60	45	74.25

Resolution	Format	Refresh rate (Hz)	H- frequency (kHz)	Pixel Frequency (MHz)
1280 x 768	1280 x 768_60*	59.87	47.776	79.5
1280 x 800	WXGA_60*	59.81	49.702	83.5
	WXGA_75	74.934	62.795	106.5
	WXGA_85	84.88	71.554	122.5
	WXGA_120** (Reduce Blanking)	119.909	101.563	146.25
1280 x 1024	SXGA_60***	60.02	63.981	108
	SXGA_75	75.025	79.976	135
	SXGA_85	85.024	91.146	157.5
1280 x 960	1280 x 960_60***	60	60	108
	1280 x 960_85	85.002	85.938	148.5
1360 x 768	1360 x 768_60***	60.015	47.712	85.5
1440 x 900	WXGA+_60***	59.887	55.935	106.5
1400 x 1050	SXGA+_60***	59.978	65.317	121.75
1600 x 1200	UXGA***	60	75	162
1680 x 1050	1680 x 1050_60***	59.954	65.29	146.25
640 x 480 @67Hz	MAC13	66.667	35	30.24
832 x 624 @75Hz	MAC16	74.546	49.722	57.28
1024 x 768@75Hz	MAC19	75.02	60.241	80
1152 x 870@75Hz	MAC21	75.06	68.68	100

* Supported timing for 3D signal with Frame Sequential, Top-Bottom and Side-by-Side format.

** Supported timing for 3D signal with Frame Sequential format.

*** Supported timing for 3D signal with Top-Bottom and Side-by-Side format.

- The timings showing above may not be supported due to EDID file and VGA graphic card limitations. It is possible that some timings cannot be chosen.

Supporting timing for HDMI Video input

Format	Resolution	Refresh rate (Hz)	H- frequency (kHz)	Pixel Frequency (MHz)
480i***	720 (1440) × 480	59.94	15.73	27
480p***	720 × 480	59.94	31.47	27
576i	720 (1440) × 576	50	15.63	27
576p	720 × 576	50	31.25	27
720/50p**	1280 × 720	50	37.5	74.25
720/60p*	1280 × 720	60	45	74.25
1080/24p**	1920 × 1080	24	27	74.25
1080/25p	1920 × 1080	25	28.13	74.25
1080/30p	1920 × 1080	30	33.75	74.25
1080/50i****	1920 × 1080	50	28.13	74.25
1080/60i****	1920 × 1080	60	33.75	74.25
1080/50p*****	1920 × 1080	50	56.25	148.5
1080/60p*****	1920 × 1080	60	67.5	148.5

* Supported timing for 3D signal with Frame Sequential, Frame Packing, Top-Bottom and Side-by-Side format.

** Supported timing for 3D signal with Frame Packing, Top-Bottom and Side-by-Side format.

*** Supported timing for 3D signal with Frame Sequential format.

**** Supported timing for 3D signal with Side-by-Side format.

***** Supported timing for 3D signal with Top-Bottom.

Warranty and Copyright information

Limited warranty

BenQ warrants this product against any defects in material and workmanship, under normal usage and storage.

Proof of purchase date will be required with any warranty claim. In the event this product is found to be defective within the warranty period, BenQ's only obligation and your exclusive remedy shall be replacement of any defective parts (labor included). To obtain warranty service, immediately notify the dealer from which you purchased the product of any defects.

Important: The above warranty shall be void if the customer fails to operate the product in accordance with BenQ's written instructions, especially the ambient humidity must be in-between 10% and 85%, temperature in-between 5°C and 28°C, altitude lower than 4920 feet, and avoiding to operate the projector in a dusty environment. This warranty gives you specific legal rights, and you may have other rights which vary from country to country.

For other information, please visit www.BenQ.com.

Copyright

Copyright 2011 by BenQ Corporation. All rights reserved. No part of this publication may be reproduced, transmitted, transcribed, stored in a retrieval system or translated into any language or computer language, in any form or by any means, electronic, mechanical, magnetic, optical, chemical, manual or otherwise, without the prior written permission of BenQ Corporation.

Disclaimer

BenQ Corporation makes no representations or warranties, either expressed or implied, with respect to the contents hereof and specifically disclaims any warranties, merchantability or fitness for any particular purpose. Further, BenQ Corporation reserves the right to revise this publication and to make changes from time to time in the contents hereof without obligation to notify any person of such revision or changes.

*DLP, Digital Micromirror Device and DMD are trademarks of Texas Instruments. Others are copyrights of their respective companies or organizations.

